

Service Manual

Dishwasher

ADP 5966 WHM

Model Version		Page
	ADP 5966 WHM	
	8542 966 10791	
	Technical data	2 - 4
	Spare part list	5 - 6
	Exploded view	7 - 8
	Circuit diagram	9
	Program diagram	10
	Text/Legend	11 - 17
	Family	VBL - HIGH 6 Sensor 2

<https://whirlpooledishwasherusermanual.wordpress.com/>



Global White

This documentation is only intended for qualified technicians who are aware of the respective safety regulations.

Date: 02.10.2003

Document-No.: 4812 718 19321

Subject to modification

Get More Manual <http://www.pdflook.com/>

Technical data

Dimension

Height	85.0	cm
Width	59.7	cm
Depth	59.6	cm
Weight	58	kg

Electronic boards

Service boards	see spare part list
Serial boards	see on the boards itself
DUB	4619 724 04851
Programing of version and programmed control board, see „Service“ and „Data set“ on rating plate of inner door:	
CB programmed	446814
Dataset	446804
Basic control board, not programmed see on the board itself	4619 724 60492

Succession of programs

Programs	see program diagram
Succession	A1a-A2a-A3a-A5a-A8a-A9a

Datas Energy Label

Reference program	A5a
Energy Performance	A
Cleaning Performance	A
Drying Performance	A

Alarms

Refill rinse aid
Refill salt

Options

Zone washing
Delay function

Program information

Start indicator
Pre wash
Main wash
Drying
End

All programs will be locked after start. Changing the program or finishing the program will be possible only after pressing the start button for longer then 1.5 sec. (Break by customer)

A switching off the appliance or unplug the appliance for a while, this will frozen the program step and later on, the program continuos on the same position.

Exception: Switching off the appliance or unplug the appliance during the drying phase, this will lead directly to the end of the program.

Water Volume at alternating spray system

Volume at alternating spray system (same level when selected zone washing as in the normal programs)

Water	Volume	Level
Regeneration	0.3 l	15 mm
Back rinse 3x	1.0 l	60 mm
Prewash	3.9 l	120 mm
Main wash	3.2 l	118 mm
Intermediate rinse 1	3.2 l	118 mm
Intermediate rinse 2	3.2 l	118 mm
Clear rinse	3.2 l	118 mm
Safety/ overflow	8.5 l	141 mm

Measuring the level

Remove the coarse sieve, put in a measuring meter into the sump, measure the hight of the water level.

Detergent max.

Pre-wash	10	cm ³
Main-wash	40	cm ³
Rinse aid	135	cm ³
6 Dosage steps	1 - 6	ml

Water softener

Saltcontainer	2	kg
Resin container	900	cm ³
Regeneration dosage	300	cm ³

<https://whirlpooldishwasherusermanual.wordpress.com/>

Technical data

Water pressure

Inlet pressure	0.3 - 10	bar
Spray pump pressure	0.3	bar

Rotations

Spray pump motor	2800	RPM
Drain pump motor	3000	RPM
Spray arm lower	30 - 40	RPM
Spray arm upper	30 - 40	RPM
Fan for drying	2500	RPM

Spray arms, turning rhythm at alternating spray system

Turning starts every time with the upper spray arm	
Pre wash	Lower arm ~3min, Upper arm ~1min
Main wash	Lower arm ~3min, Upper arm ~5min
Intermediate rinse	Lower arm ~2min, Upper arm ~2min
Final rinse	Lower arm ~2min, Upper arm ~2min
Service Test program	Lower arm ~30sec, Upper arm ~30sec

Remark: When switching of the mains switch or interrupt the mains during the Test Program runs, then the alternating of the spray arms change in the test program to the rhythm of main wash 5/3 min.

Important: To leaf the Test program is possible by made a break by customer (pushing the start button for 1.5 sec.)

After finishing the test program (End LED shines and/or Start LED goes of) must the appliance be switched off.

If this will not be done, then the next normal wash will be made with the frequency of the Service Test Program ~30/30sec.

Flow rates/ Inlet volume

Flow meter (at 0.3 bar = quantity 1.1 l/min)	208	lmp/l
Spray pump	45 - 65	l/min
Drain pump	16	l/min
Pump height max.	1.1	m
Inlet valve	4	l/min
Spray arm lower	~ 33	l/min
Sprayarm upper	~ 27	l/min
Ceiling rotor	~ 8	l/min
Fan for drying:		
Total	900	l/min
Primary air flow	210	l/min
Secondary air flow	780	l/min

Electrical base data

Voltage	230-240	V
Frequency	50	Hz
Total power	2.4	kW
Fuse	13	A

Spray pump motor alternating spray system

Voltage	220/ 240	V
Power consumption	125	W
HI	79	Ω
HA	60	Ω
Capacitor	4	μ F

Drain pump motor

Voltage	220/ 240	V
Power consumption	30	W
Resistance	146	Ω

Fan for drying

Voltage	220 - 240	V
Resistance	141	Ω

<https://whirlpooldishwasherusermanual.wordpress.com/>

Heating Element system

Voltage	230-240	V
Power consumption	2.04-2.22	kW
Resistance	24.5	Ω
Heating speed	~ 2.0	°C/min
Temperature on surface	~ 115	°C
Safety thermostat self reset (Temperature of water)	~ 85	°C
Fuse	206	°C

Potentiometer

Points of measurement:	1 (black) to 2 (middle)
Position 0	0.0 kΩ
Position 1	0.5 kΩ
Position 2	1.0 kΩ
Position 3	1.4 kΩ
Position 4	1.8 kΩ
Position 5	2.3 kΩ
Position 6	2.6 kΩ

Technical data

Single electric inlet valve

Voltage	220/ 240	V
Frequency	50/ 60	Hz
Resistance	3.76	kΩ

Regenerating valve

Voltage	220/ 240	V
Frequency	50/ 60	Hz
Resistance	3.13	kΩ

Motor Diverter Valve

Voltage	220 - 240	V
Frequency	50/ 60	Hz
Resistance	6.5	kΩ
Signal (2x within ~13 sec.)	5.0	V

Coil of dispenser

Voltage	220/ 240	V
Frequency	50/ 60	Hz
Resistance	1.3	kΩ

Reed contacts

- flow meter
- salt control
- rinse aid control

Optical water indicator (OWI)

Optical measurement of the water in sump
 Combination part of:
 Turbidity sensor (DON)
 Thermostat temp. sensor (notice NTC)

NTC

20 °C	58.1	kΩ
25 °C	47.1	kΩ
30 °C	38.2	kΩ
40 °C	25.4	kΩ
50 °C	17.2	kΩ
60 °C	11.8	kΩ
70 °C	8.3	kΩ
80 °C	6	kΩ
85 °C	4	kΩ

Regeneration

Volume	300	cm ³
Position 0 after wash cycles	12	
water hardness	0 - 5	°dh
	0 - 0.9	mmol/l
	0 - 9	°Fh
Position 1 after wash cycles	10	
water hardness	6 - 10	°dh
	1 - 1.8	mmol/l
	10 - 18	°Fh
Position 2 after wash cycles	7	
water hardness	11 - 15	°dh
	1.9 - 2.7	mmol/l
	19 - 27	°Fh
Position 3 after wash cycles	5	
water hardness	16 - 21	°dh
	2.8 - 3.7	mmol/l
	28.37	°Fh
Position 4 after wash cycles	3	
water hardness	22 - 28	°dh
	3.8 - 5.0	mmol/l
	30 - 30	°Fh
Position 5 after wash cycles	2	
water hardness	29 - 35	°dh
	5.1 - 6.3	mmol/l
	51 - 63	°Fh
Position 6 after wash cycles	1	
water hardness	36 - 60	°dh
	6.4 - 10.7	mmol/l
	64 - 107	°Fh
Salt consumption for regeneration	77	g
Number of cycles with 2 kg salt	26	

Accessory

If you need spare parts apart from the spare part list have a look in the Service Bulletin 4812 718 40084.

<https://whirlpooldishwasherusermanual.wordpress.com/>

Spare part list

Model ADP 5966 WHM
Service No. 854296610791
Version 854296610791

Pos. No.	12NC Code	Description
003 0	4812 440 19594	Traverse
004 0	4812 440 18952	Drip tray assy
004 1	4812 401 18402	Holder
011 0	4812 505 18357	Foot short
022 0	4812 440 10755	Side panel left
022 1	4812 440 10754	Side panel right
024 0	4812 440 10417	Panel, rear
030 0	4812 440 10763	Table top WH
034 0	4812 404 78237	Spacer
034 1	4812 404 78242	Fastener table top
040 1	4812 417 18774	Hinge left
040 2	4812 417 18773	Hinge right
040 3	4812 417 19174	Protector f.door (set)
044 0	4812 492 38358	Spring f.door
047 0	4812 404 48746	Brake f.door
047 1	4812 401 18397	Band,brake
047 2	4812 404 68023	Hook
053 0	4812 440 89032	Plinth WH
053 4	4812 440 89034	Plinth rounded WH
065 0	4812 466 48051	Insulation
103 0	4812 440 10762	Door outer WH
103 2	4812 440 10766	Corner piece set
120 0	4812 440 19456	Door,inner
110 0	4812 440 18959	Spring
130 0	4812 417 58361	Tilt lock cpl. wh
131 0	4812 401 18416	Hook lock
191 0	4812 466 68564	Gasket door
191 3	4812 466 68533	Gasket
192 0	4812 466 68467	Gasket, door lower
241 0	4812 458 19026	Basket upper straight
241 1	4812 458 18324	Holder cups right wh
241 3	4812 528 88068	Wheel,basket upper (set)
241 4	4812 458 18984	Holder dishes wh
241 5	4812 535 78043	Bearing
241 6	4812 310 18757	Holder glasses KIT wh
241 7	4812 404 48683	Hoop
241 8	4812 466 68553	Spacer cap set
242 0	4812 458 18974	Basket lower cpl.
242 1	4812 528 88069	Wheel,basket lower wh
242 4	4812 466 48059	Fixation wh
242 6	4812 458 18977	Support plate left
242 7	4812 458 18978	Support plate right
243 0	4812 458 18272	Basket cutlery
243 5	4819 310 39859	Cutlery basket KIT
243 6	4812 458 18996	Grille wh
261 0	4819 462 38271	Rail telescope, inner
261 1	4812 462 79768	Cap rail
261 2	4812 462 78995	Cap rail ahead
263 0	4819 520 18013	Ball cage cpl.
263 1	4812 520 48001	Ball Niro 8 D
265 0	4812 404 48637	Basket adjustm. cpl.
265 2	4812 404 48638	Grip basket adjustment
303 1	4812 460 38134	Plate,handle WH
322 0	4812 453 71956	Insert panel
331 0	4812 413 59143	Knob program cpl. WH

Pos. No.	12NC Code	Description
332 0	4812 410 29032	Button WH
332 1	4812 410 29053	Button WH
400 0	4812 361 58336	Motor +SP,50Hz,alt.LP-PNT1
405 0	4812 360 18509	Spray pump wo.Mot.alt.LP-50Hz
405 1	4819 515 28158	Gasket
420 0	4812 121 18132	Capacitor
421 0	4812 121 18158	Interf.filter
430 0	4812 360 18508	Pump,draining cpl.
430 1	4812 466 68689	Gasket
442 0	4812 361 18196	Blower cpl.
450 0	4812 259 28684	Heating element
480 0	4812 321 28405	Cable harness set
480 3	4812 401 18418	Protector f.wiring
490 0	4819 321 18136	Cable,mains 2m SA
490 1	4812 321 28367	Strain relief
521 0	4812 214 78704	Control board (CB)
531 0	4812 273 18055	Switch waterhardness
531 1	4812 273 18056	Wheel, fingertip
575 0	4812 281 28361	Regen.valve
583 0	4812 271 28459	Switch diaphragm (OWI)
616 0	4812 281 18047	Contact,reed salt
616 1	4812 271 58161	Contact,reed rinsing agent
620 0	4812 310 28066	User board KIT (DUB)
623 0	4812 271 38936	Microswitch
633 0	4812 271 38355	Microswitch door
680 0	4812 418 68155	Combidosage
680 1	4812 466 68495	Gasket
681 1	4812 466 68497	Gasket
681 2	4812 440 18975	Flap
682 0	4812 466 68496	Gasket
691 1	4812 462 79769	Stopper NTC
700 0	4812 530 28804	Hose, inlet aqua stop 4,2m
700 0	4812 530 28848	Hose, inlet aqua stop 2m
700 1	4812 480 48095	Sieve
700 2	4812 466 68628	Gasket
701 1	4812 310 18153	Yoke clamp set
710 0	4812 418 68151	Monoblock
710 2	4819 310 38536	Threaded ring
710 3	4819 466 69562	Gasket set
714 0	4812 462 78993	Threaded cap
716 0	4812 418 68147	Reg.dosage
716 1	4812 466 68475	Gasket
716 2	4812 462 78994	Cover
717 0	4812 281 28418	Valve motordiverter
717 2	4812 528 98011	Valve disk diverter
717 3	4812 530 29121	Gasket diverter valve
721 1	4812 360 68347	Spray arm lower. cpl.
722 0	4812 360 68348	Spray arm upper wh
722 2	4812 360 68349	Spray arm 2nd level cpl. wh
723 0	4812 360 68351	Douche ceiling
726 1	4812 530 29118	Tube assembly cpl.
726 2	4812 505 18208	Nut
743 0	4812 530 48134	Air guide
743 1	4812 530 28102	Hose, inlet
743 2	4812 440 19526	Air guide lower

<https://whirlpooldishwasherusermanual.wordpress.com/>

Spare part list

Model ADP 5966 WHM
Service No. 854296610791
Version 854296610791

Pos. No.	12NC Code	Description
743 3	4812 505 18364	Nut
743 4	4812 281 38001	Valve disk
743 5	4812 466 98934	Disc
743 7	4812 466 68514	Gasket
751 0	4812 418 18338	Water collector
755 0	4812 530 29119	Bend
755 2	4812 530 48148	Tray,leak
756 0	4812 360 58099	Floater
761 0	4812 480 58122	Sieve fine
761 2	4812 418 18337	Cover sieve
761 3	4812 418 18341	Cover
761 4	4812 530 58141	O-Ring
763 0	4812 480 58123	Sieve coarse
781 0	4812 530 29113	Hose,draining
781 3	4812 281 28417	Flap non-return
783 6	4812 530 28796	Hose 10x3x180+10
791 0	4812 532 68099	Gasket
791 2	4812 530 58093	Gasket
901 0	4822 401 10258	Clamp,hose 10-18 mm
901 1	4812 401 18424	Strap 050,0
901 2	4812 401 18157	Strap 32-50/9 C61
901 5	4812 401 48573	Strap 028,6
904 2	4812 462 79635	Cover WH 3,5x5
910 1	4812 502 38152	Screw 4x8x18
910 2	4812 502 18363	Screw 4,0x12-H
910 3	4812 502 18389	Screw 5x20 T20
910 4	4812 502 18385	Screw M3,5x8-T15M
910 5	4812 502 18393	Screw 3,5x9-1 Tx15
910 7	4812 502 18397	Screw INOX A2 M 5X12
910 8	4812 502 18527	Screw 4x15 T20
910 9	4812 502 18446	Screw 3,5x16
964 0	4812 466 68536	Gasket housing ri/le
964 1	4812 466 68469	Gasket housing upper
993 0	4819 530 29028	Bow
993 5	4822 532 80216	Funnel salt

<https://whirlpooldishwasherusermanual.wordpress.com/>

Exploded view

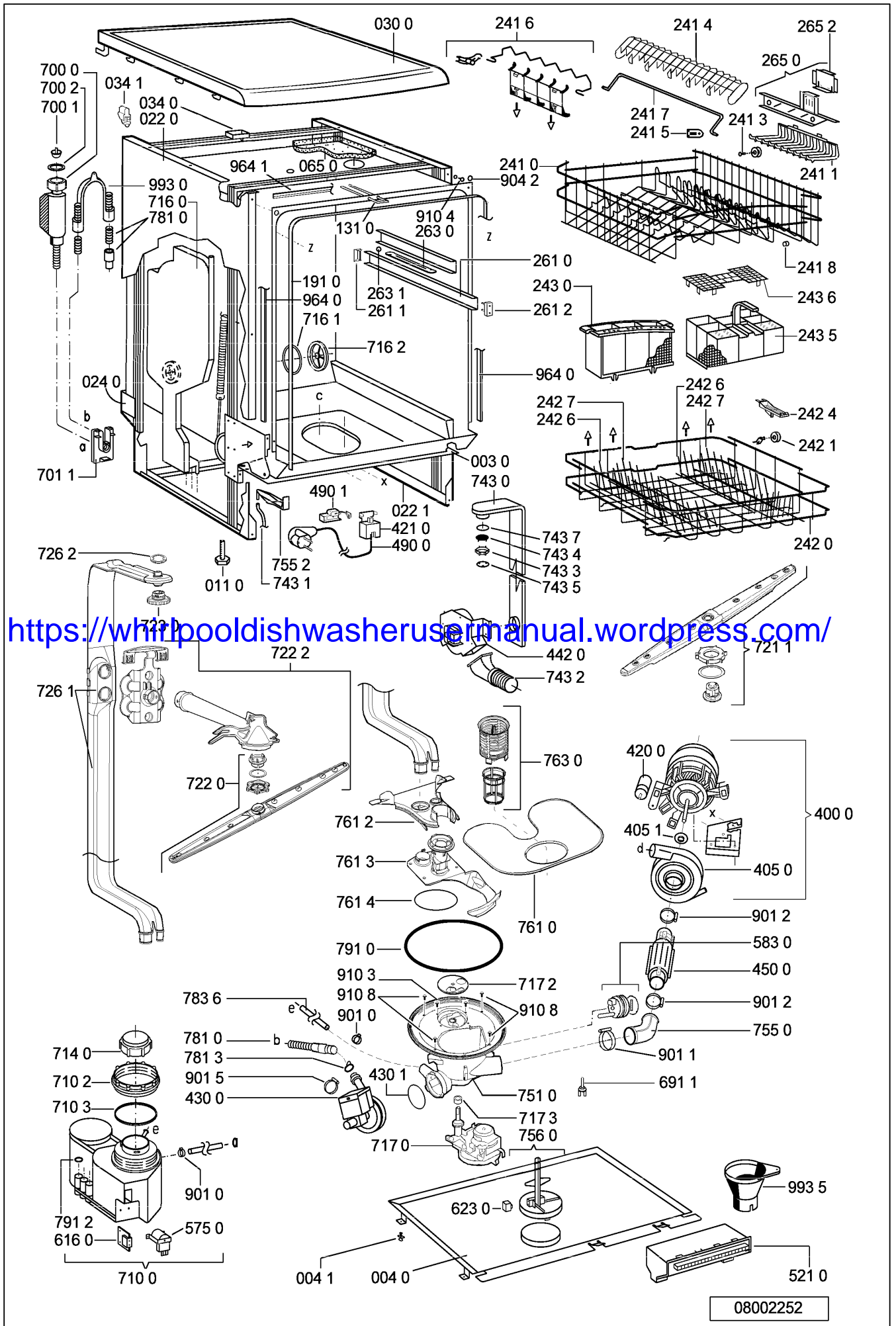

Exploded view

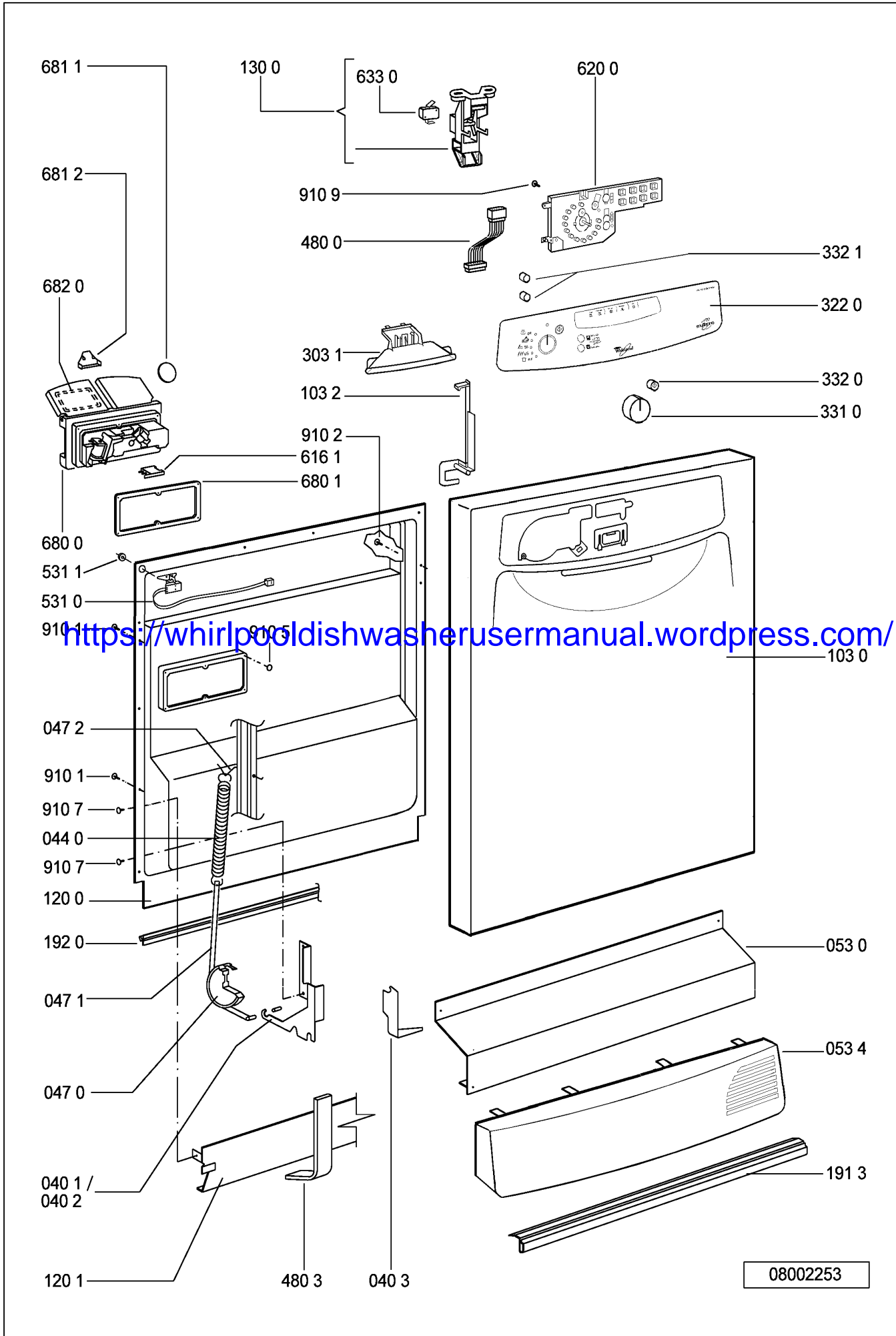

Text/Legend

**Test procedure for SERVICE-TEST-PROGRAM Point dishwashers
appliances with and without 7 Segment Display**

Switch on the appliance. If there is no failure indicated, then:

1. Start the passive test program.
If there is a defective component indicated, open the plinth and take out the control board (CB).
2. Check the component.
Unplug the indicated component from the control board (CB) and check it by using an Ohmmeter
If the resistance is not correct, check the cables to the component and check the component itself.
3. Visibly check the control board (CB).
4. At the end of the repair start the appliance and delete the failure. After this, start the passive and active test program again to see that the failure is solved.

More details: see following pages.

Attention:

Danger for short circuit. Short circuits on components can damage the control board (CB).

If electronic boards are wet, do not switch the appliance on.

To check the appliance, plug in the appliance.

Failures, which occurred during the program will be stored and indicated by flashing the start LED.

The failure will be indicated and can be related to the failure table.

To erase the failures, you must push the start button longer than 1,5 seconds.

<https://whirlpooldishwasherusermanual.wordpress.com/>

The failures:

- F1 No tub leak
- F2 water leakage
- F9 continuous water inlet

are checked and indicated immediately after start of the program.

Therefore these failures have to be solved before starting the active test program.

When these failures are not solved, the active test program does not run.

The electrical components get their voltage via triac from the control board (CB). To test the voltage the voltmeter must be connected in parallel to the component (the component must be connected). If the component is disconnected, then the output voltage from the control board (CB) is reduced.

After starting a program this program is locked. That means neither by unplugging/switching off the appliance nor by setting to another program, the first set program cannot be changed. Changing of the program is only possible by pushing the start button again for longer than 1,5 sec..

Attention: New service control boards start at first with the service test program. This test program is without back rinsing. Dangerous for overfilling the appliance, in case the appliance is not empty. By running the test program or another program a second time, the back rinsing will be carried out as usual.

4619 724 43901-1

Text/Legend

Handling of failures

- F0 Sensor failure (only when a dirt sensor is installed)
Will not be indicate to the customer. The programs will finish even if there is a failure. The Failure is indicated only in the active test program after 10 – 30 second's. The active test program will finish as well, even if there is a failure.
If the failure in a sensor program appears, the machine will always choose the highest consumption (best cleaning result).
- None or wrong output from the sensor
 - Unlogical or unreal measurement results
- Reason:
- Defective electronic of the sensor
 - Optoelectronic parts in the sensor defect
 - The sensor is very dirty
 - Connection between sensor and control board (CB) interrupted
- Attention: The failure code will not store.

- F1. NTC break
Temperature out of the normal value (-3°C till +85°C)
- Temperature inside higher than +85°C
 - NTC defective
 - Dishwasher is frozen, less than -3°C
- If the temperature is less than -3°C, fill the appliance with a cup of warm water to warm it up before you start it.

<https://whirlpooldishwasherusermanual.wordpress.com/>

- F2. Water Leakage
- Water is in the drip tray
- Floater (LS6) switches off the WV1 and the electronic switches on the DPM until WI reports that it is empty.

- F3. Heating System Defective
Indicated after app. 25 minutes (1. check after 5 min., after that follow 2 more checks, before the failure is indicate)
- Heats too slowly (less than 1,5 °C in 10 min.)
 - Heating (HEW) defective
 - Relays (RE2) on control board (CB) is defective
 - NTC - resistance fluctuation

- F4. Draining Failure
Drain pump starts and after 4 min. the WI detects that it is "not empty"
- Drain pump (DPM) defective
 - Siphon closed
 - Control board (CB) defective
 - OWI/WI defective.

Text/Legend

- F6. Water Tap Closed
Water valve (WV1) is switched on but flow meter (FM) sends no impulses (less than 10 imp. in 10 sec.) and the water indicator (WI) is off (empty)
- Water tap closed
 - Water inlet hose blocked
 - Water inlet valve (WV1) defective
 - Flow meter (FM) defective (leads to FM failure)

- F7. Flow Meter Failure
Water inlet valve (WV1) is switched on and the water indicator (WI) is on (full).
- Flow meter (FM) sends too few impulses (less than 10 imp. in 10 sec.)
 - Water tap closed during water inlet
 - Water inlet hose blocked
 - Water inlet valve (WV1) defective
 - Flow meter (FM) defective

- F8. Water Level Failure.
Failures are supervised over the whole program.
Mechanical water indicator WI: Spray pump works, the WI switches more than 20 times in 2 minutes back.
Optical water indicator OWI: Always after the OWI-Signal is missing, the electrical components are turned off for 5 sec. If after the 5 sec. the OWI-Signal is still not present then, it notes a Failure F8. If, however, after the 5 sec. the OWI-Signal is present, then the water-level is filled to 6 Ltr. and the electrical components are again turned on. After the OWI signal is missing for a second time note an F8 Failure.
- WI defect? Should switch on after approx. 1 Ltr
 - Sieve blocked
 - Water strongly foams
 - Pot has turned off and is filled with spray water
 - No stable spray pump (SPM) working

- F9. Continuous Water Inlet
Water inlet valve (WV1) is switched off, water indicator (WI) on, flow meter (FM) sends impulses (more than 10 imp. in 10 sec.)
- Water inlet valve (WV1) mechanically not closed
 - Triac (CB) permanently switched on. (short circuit)
- Reaction: interval 30 sec. drain pump on / 20 sec. drain pump off in interval

The following failures will only be indicated, when the relevant component is installed.

<https://whirlpooldishwasherusermanual.wordpress.com/>

Text/Legend

FA. OWI (Optical Water Indicator) – Failure

If the electronics signals of the Flow meter for the 3,4 Ltr. of water has been received on permanent wash system and 2,5 Ltr on alternating wash system and the OWI signal "Water in the sump" is missing then take note.

- Lens will be cleaned: Water inlet off for 10 Sec and SPM on for 10 Sec.
- If after that there is still no signal "Water in sump", then the appliance goes into failure mode FA.

FB. MDV (Motor Diverter) – Failure

Failure condition:

Start water inlet. After 15 sec. switches the WI. After that, when not within 120 sec. comes a signal from the MDV to the control board, lower or upper spray arm is functioning, then the FB will indicate.

Check:

- Do the upper and lower spray arms alternate turns in approx. 30-40 sec.? If only one turns then there is a failure.
- Is the diverter disc in the sump blocked? Yes, unblock it.
- Does 230V come from the control board (ZW,DVH) to the MDV? No, change control board.

How to check:

Start test program and wait until backrinse is over. After the start of the regular water-inlet must come 230V within 30 sec. for approx. 20 sec. to the MDV.

- Is the winding of the MDV or cable to the MDV interrupted? (ZW,DVH) resistance of the MDV should be approx. 100 Ω.
- Is the signal cable between the MDV and control board (SAB,DVL) carrying 5v?

<https://whirlpooldishwasherusermanual.wordpress.com/>

FC. ASA (Automatic Salt Adaptation)/ Water hardness sensor Failure (only indicates in the active test program)

Failure condition:

Electronic on the water softener detects high electrical resistance in the resin.

Check:

























Cables on the sensors of the water softener interrupted or weak contact? Cables from the control board (ASA) to WHS electronic on the water softener interrupted or weak contact?

For salt, rinse aid, zone wash valve, sieve valve failure see active test program.

Text/Legend

Failure Display POINT

Appliances with 1 and 2-digit 7 Segment Display and without 7 Segment Display

Alarm / Failure	Failure code, Indication in test program when a failure occurs	
	Shown with 7 segment display or without 7 segment display	Shown on 2/3 digit 7 segment display
F1 NTC-Failure	START  1 x flash 1s Pause 1 x flash.....	
F2 Water Leakage	START  2 x flashes 1s Pause 2 x flashes.....	
F3 Failure in Heating System	START  3 x flashes 1s Pause 3 x flashes.....	
F4 Draining Failure	START  4 x flashes 1s Pause 4 x flashes.....	
F6 Water Tap closed	START  6 x flashes 1s Pause 6 x flashes.....	
F7 Flow Meter Failure	START  7 x flashes 1s Pause 7 x flashes.....	
F8 Water Level Failure	START  8 x flashes 1s Pause 8 x flashes.....	
F9 Continuous Waterinlet	START  9 x flashes 1s Pause 9 x flashes.....	
F0 Sensor-Failure (Only displayed in act. test program)	START  10 x flashes 1s Pause 10 x flashes.....	
FA OWI-Fehler	START  11 x flashes 1s Pause 11 x flashes.....	
FB MDV-Fehler	START  12 x flashes 1s Pause 12 x flashes.....	
FC ASA-Fehler (Only displayed in act. test program)	START  13 x flashes 1s Pause 13 x flashes.....	

<https://whirlpooldishwasherusermanual.wordpress.com/>

 LED flashing

- "Rotor blocked (F5)" isn't displayed on the POINT appliance

Text/Legend

With the passive test program, you can check all LED's and buttons. If there is no failure the passive test program runs normally.

Attention:

If you can't start the active test program (Start button doesn't flash), normally there is one of the following failures detected: F1, F2 or F9

When these failures are not solved before, the passive and active test program will not run. After solving the failure you must "sign" (erase) the failure.

A present failure will be indicate directly after you switch on the appliance. Then fix the mistake, erase failure and start test program again (see following start procedure).

Start procedure

Start the passive test program if there is no failure indicated

If there is no failure the passive test program runs normally.

<https://whirlpooldishwasherusermanual.wordpress.com/>

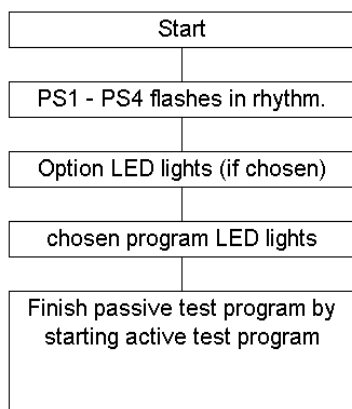

1. Turn OFF appliance
2. Push start button and hold it.
3. Select program position 1.(turn to the right or with WP VBL turn to the left)
4. Finish pushing the start button when the start LED flashes.
5. Test all LEDs by operating the buttons and the program knob. After the check, turn the program knob on to program place 1
6. Start the active test program by pushing the start button again
7. Failure indication.
8. Repair the failure
9. Solve the failure by pushing the start button for longer than 1,5 sec.
10. Start the active test program again, to see, if the failure is really solved

Active test program starts (see next page)

PS1	1.LED	prewash		
PS2	2.LED	mainwash		
		intermediate rinse		
		final rinse		
PS3	3.LED	drying (regeneration)		
PS4	4.LED	end	goes off if any button is pushed	goes off if after 30 min prog. Is finished

Text/Legend

Active test program

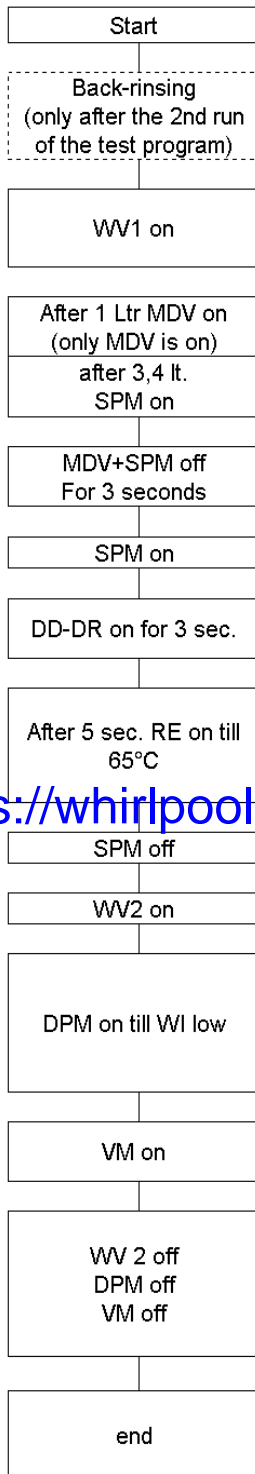

<https://whirlpooldishwasherusermanual.wordpress.com/>

Remarks

The active test program runs to the failure position and stops or, if there is no failure, it runs to the end.

To leave the test program push the start button for longer than 1,5 second's.

Not enough salt or rinse aid will not stop the running of the appliance.

Remark When switching off the main switch or interrupting the mains, during the test program runs, then the alternating of the spray arms changes in the test program from 30/30 sec. to the rhythm of the main wash 5/3 min.

Important Leaving the test program is possible by making a break by the customer (Pushing the start button for more than 1,5 sec.).

After finishing the test program (End LED shines and/or Start LED goes off) then the appliance must be switched off.

If this is not done, then the next main wash will be made with the frequency of the Service Test Program ~30/30 sec. instead of 3/5 min.

When the failure position is reached the failure indication is indicated on the page "Failure Codes"

Attention:

If you can't start the active test program (Start button doesn't flash), normally there is one of the following failures detected: F1, F2 or F9

When these failures are not repaired before, the active test program will not run. After solving the failure you must "sign" (erase) the failure.

Only on this step can be jumped to the next step by short pushing the start button again. Before jumping to the next step, wait for 3 minutes, to be sure, there is no FB failure.