

Service Manual

Dishwasher

ADP 2656 WHM

Model Version		Page
	ADP 2656 WHM	
	8542 656 10510	
	Technical data	2 - 4
	Spare part list	5 - 6
	Exploded view	7 - 8
	https://whirlpooledishwasherusermanual.wordpress.com/	9
	Program diagram	10
	Text/Legend	11 - 16
	Family	VBL - B6

This documentation is only intended for qualified technicians who are aware of the respective safety regulations.

Date: 20.10.2000

Document-No.: 4812 718 15739

Subject to modification

Technical data

Dimension

Height	85.0	cm
Width	59.7	cm
Depth	59.6	cm
Weight	61.3	kg

Electronic boards

Service boards	see spare part list
Serial boards	
DUB	4619 724 06781
CB	411911
Dataset	411901

Succession of programs

Programs	see program diagram
Succession	1a-3b-4f-5a-6a-7a

Alarms

Refill rinse aid
Refill salt

Options

Zone washing
Delay function

Datas Energy Label

Energy Performance	C
Cleaning Performance	A
Drying Performance	C
Reference program	4f

Program information

Start indicator
Pre wash
Main wash
Drying
End

Volume (normal program)

Water	Volume	Level
Regeneration	0.3 l	15 mm
Back rinse 3x	1.0 l	68 mm
Prewash	4.8 l	122 mm
Prewash/Zone washing	4.0 l	120 mm
Main wash	4.5 l	121 mm
Main wash/Zone washing	3.5 l	117 mm
Intermediate rinse 1	4.0 l	120 mm
Intermediate rinse 1/		
Zone washing	3.5 l	117 mm
Intermediate rinse 2	4.0 l	120 mm
Intermediate rinse 2/		
Zone washing	3.5 l	117 mm
Clear rinse	4.0 l	120 mm
Clear rinse/Zone washing	3.5 l	117 mm
Safety / overflow	8.5 l	141 mm

Measuring the level

Remove the coarse sieve, put in a measuring meter into the sump, measure the height of the water level.

Detergent max.

Main-wash	45	cm ³
Rinse aid	125	cm ³
6 Dosage steps	1 - 6	ml

Water softener

Saltcontainer	2	kg
Resin container	900	cm ³
Regeneration dosage	300	cm ³

Water pressure

Inlet pressure	0.3-10	bar
Spray pump pressure	0.4	bar

Rotations

Spray pump motor	2800	RPM
Drain pump motor	3000	RPM
Spray arm lower	20 - 40	RPM
Spray arm upper	25 - 35	RPM
Ceiling rotor	45 - 65	RPM

<https://whirlpooldishwasherusermanual.wordpress.com/>

Technical data

Flow rates / Inlet volume

Flow meter (at 0.3 bar = quantity 1.1 l/min)	208	lmp/l
Spray pump	~ 70	l/min
Drain pump	16	l/min
Pump height max.	1.1	m
Inlet valve	4.5	l/min
Valve for Zone washing	30	l/min
Spray arm lower	~ 33	l/min
Sprayarm upper	~ 27	l/min
Ceiling rotor	~ 10	l/min

Electrical data

Base data

Voltage	220/230	V
Frequency	50	Hz
Total power	2.0-2.2	kW
Fuse	10	A

Motor

Spray pump motor

Voltage	220/230	V
Power consumption	160	W
HI	81	Ω
HA	44	Ω
Capacitor	4	μ F

Drain pump motor

Voltage	220/240	V
Power consumption	30	W
Resistance	146	Ω

Heating

1 Element system

Voltage	220/230	V
Power consumption	1.87/2.04	kW
Resistance	24.5	Ω
Heating speed	~ 2.0	$^{\circ}$ C/min
Temperature on surface	~ 115	$^{\circ}$ C
Safety thermostat self reset	85	$^{\circ}$ C

Potentiometer

Points of measurement:	1 (black) to 2 (middle)
Position 0	0.0 k Ω
Position 1	0.5 k Ω
Position 2	1.0 k Ω
Position 3	1.4 k Ω
Position 4	1.8 k Ω
Position 5	2.3 k Ω
Position 6	2.6 k Ω

Water valves

Single valve at inlet hose

Voltage	220/240	V
Frequency	50/60	Hz
Resistance	3.76	k Ω

Regenerating valve

Voltage	220/240	V
Frequency	50/60	Hz
Resistance	3.13	k Ω

Valve for zone washing

Voltage	220-240	V
Frequency	50/60	Hz
Resistance	4	k Ω

Coil of dispenser

Voltage	220/240	V
Frequency	50/60	Hz
Resistance	1.5	k Ω

Reedcontact

flow meter
salt control
rinse aid control

NTC

20 $^{\circ}$ C	58.1	k Ω
25 $^{\circ}$ C	47.1	k Ω
30 $^{\circ}$ C	38.2	k Ω
40 $^{\circ}$ C	25.4	k Ω
50 $^{\circ}$ C	17.2	k Ω
60 $^{\circ}$ C	11.8	k Ω
70 $^{\circ}$ C	8.3	k Ω
80 $^{\circ}$ C	6	k Ω
85 $^{\circ}$ C	4	k Ω

<https://whirlpooldishwasherusermanual.wordpress.com/>

Technical data

Regeneration

Volume	300	cm ³
Position 0 after wash cycles water hardness	10 0-5 0-0.9 0-9	°dh mmol/l °Fh
Position 1 after wash cycles water hardness	8 6-10 1-1.8 10-18	°dh mmol/l °Fh
Position 2 after wash cycles water hardness	6 11-15 1.9-2.7 19-27	°dh mmol/l °Fh
Position 3 after wash cycles water hardness	4 16-21 2.8-3.7 28.37	°dh mmol/l °Fh
Position 4 after wash cycles water hardness	3 22-28 3.8-5.0 38-50	°dh mmol/l °Fh
Position 5 after wash cycles water hardness	2 29-35 5.1-6.3 51-63	°dh mmol/l °Fh
Position 6 after wash cycles water hardness	1 36-60 6.4-10.7 64-107	°dh mmol/l °Fh
Salt consumption for regeneration	77	g
Number of cycles with 2 kg salt	26	

Accessory

If you need spare parts apart from the spare part list have a look in the Service Bulletin 4812 718 40084.

<https://whirlpooldishwasherusermanual.wordpress.com/>

Spare part list

Model ADP 2556 WHM
Service No. 854265610510
Version 854265610510

Pos. No.	12NC Code	Description
003 0	4812 440 19594	Traverse
004 0	4812 440 18952	Drip tray assy
004 1	4812 401 18402	Holder
011 0	4812 505 18357	Foot short
022 0	4812 440 18951	Side panel left
022 1	4812 440 18949	Side panel right
024 0	4812 440 19463	Panel, rear
030 0	4812 440 19755	Table top WH
034 0	4812 404 78237	Spacer
034 1	4812 404 78242	Fastener table top
040 1	4812 417 18774	Hinge left
040 2	4812 417 18773	Hinge right
040 3	4812 417 18923	Protector f.door (set)
044 0	4812 492 38358	Spring f.door
047 0	4812 404 48591	Brake f.door
047 1	4812 401 18397	Band,brake
047 2	4812 404 68023	Hook
053 0	4812 440 88887	Plinth WH
053 4	4812 440 88928	Plinth rounded WH
103 0	4812 440 19833	Door outer WH
103 2	4812 440 19778	Corner piece set
120 0	4812 440 19456	Door,inner
120 1	4812 440 18969	Batten
130 0	4812 417 18351	Pin lock cpl. WH
131 0	4812 401 18416	Hook lock
191 0	4812 466 68564	Gasket door
192 0	4812 466 68467	Gasket, door lower
241 0	4812 458 18912	Basket upper straight
241 1	4812 458 18324	Holder cups right wh
241 3	4812 528 88068	Wheel,basket upper (set)
241 4	4812 458 18984	Holder dishes
241 5	4812 535 78043	Bearing
241 6	4812 458 18979	Holder glasses
241 7	4812 404 48683	Hoop
241 8	4812 466 68553	Spacer cap set
242 0	4812 458 18974	Basket lower cpl.
242 1	4812 528 88069	Wheel,basket lower
242 4	4812 466 48059	Fixation
242 6	4812 458 18977	Support plate left
242 7	4812 458 18978	Support plate right
243 0	4812 458 18272	Basket cutlery
243 5	4819 310 39859	Cutlery basket KIT
243 6	4812 458 18996	Grille
261 0	4819 462 38271	Rail telescope, inner
261 1	4819 404 48819	Cap rail
261 2	4812 462 78995	Cap rail ahead
263 0	4819 520 18013	Ball cage cpl.
263 1	4812 520 48001	Ball Niro 8 D
265 0	4812 404 48637	Basket adjustm. cpl.
265 2	4812 404 48638	Grip basket adjustment
303 1	4812 460 38092	Plate,handle WH
322 0	4812 453 70978	Insert panel
331 0	4812 413 59028	Knob program cpl. WH
332 0	4812 410 28669	Button WH
332 1	4812 410 28735	Button WH

Pos. No.	12NC Code	Description
400 0	4812 361 58126	Motor + spraypump cpl.
405 0	4812 360 18371	Spray pump
405 1	4819 515 28158	Gasket
420 0	4812 121 18132	Capacitor
421 0	4812 121 18161	Interf.filter
430 0	4812 360 18357	Pump,draining
430 1	4812 466 68506	Shaft seal
450 0	4812 259 28684	Heating element
480 0	4812 321 28394	Cable harness set
480 1	4812 321 28371	Cable
480 3	4812 401 18418	Protector f.wiring
490 0	4819 321 18136	Cable,mains 2m SA
490 1	4812 321 28367	Strain relief
521 0	4812 214 78428	Control board (CB)
531 0	4812 273 18055	Switch waterhardness
531 1	4812 273 18056	Wheel,fingertip
571 3	4812 281 28363	Valve f.zone-washing
575 0	4812 281 28361	Regen.valve
583 0	4812 271 28407	Switch diaphragm
616 0	4812 281 18047	Contact,reed salt
616 1	4812 271 58161	Contact,reed rinsing agent
620 0	4812 218 38101	User board (DUB)
623 0	4812 271 38356	Microswitch
633 0	4812 271 38355	Microswitch
680 0	4812 418 68155	Combidosage
680 1	4812 466 68495	Gasket
681 1	4812 466 68497	Gasket
681 2	4812 440 18975	Flap
682 0	4812 466 68496	Gasket
691 0	4812 282 68012	Feeler NTC
700 0	4812 530 28804	Hose, inlet aqua stop 4,2m
700 0	4812 530 28848	Hose, inlet aqua stop 2m
700 1	4812 480 48095	Sieve
700 2	4812 466 68628	Gasket
701 1	4812 310 18153	Yoke clamp set
710 0	4812 418 68151	Monoblock
710 2	4819 310 38536	Threaded ring
710 3	4819 466 69562	Gasket set
714 0	4812 462 78993	Threaded cap
714 2	4812 440 18963	Cabinet non-return flap
716 0	4812 418 68147	Reg.dosage
716 1	4812 466 68475	Gasket
716 2	4812 462 78994	Cover
721 1	4812 360 68061	Spray arm lower. cpl.
721 2	4812 466 68491	Gasket 25x2,3B
721 3	4812 466 68558	Gasket 30x3,0
721 4	4812 440 19455	Flange
722 0	4812 360 68044	Spray arm upper
722 2	4812 360 68056	Hub upper straight cpl.
723 0	4812 360 68049	Spray arm ceiling
723 1	4819 310 39831	Kit
726 0	4812 530 28786	Tube
726 1	4812 530 28787	Tube
726 2	4812 505 18358	Nut
726 3	4812 466 68512	Gasket

<https://whirlpooldishwasherusermanual.wordpress.com/>

Spare part list

Model ADP 2556 WHM
Service No. 854265610510
Version 854265610510

Pos. No.	12NC Code	Description
726 4	4812 462 79633	Centering
743 0	4812 511 48171	Capacitor
743 1	4812 530 28102	Hose, inlet
743 3	4812 505 18364	Nut
743 4	4812 530 28807	Hose 9x1,5x270+10
743 7	4812 466 68514	Gasket
751 0	4812 418 18205	Water collector
751 1	4819 310 39826	Water guide service kit
755 0	4812 530 28849	Bend
755 2	4812 530 48148	Tray,leak
756 0	4812 360 58099	Floater
761 0	4812 480 58082	Sieve fine
761 2	4812 418 18204	Cover sieve
762 0	4812 480 58084	Microfilter
763 0	4812 480 58083	Sieve coarse
781 0	4812 530 28737	Hose,draining
781 1	4819 530 28286	Sleeve hose
781 2	4819 492 68405	Clip f.non-return valve
781 3	4812 281 28364	Flap non-return
783 1	4812 530 28806	Hose connection
783 5	4812 530 28851	Distributor
783 6	4812 530 28796	Hose 10x3x180+10
791 0	4812 532 68067	Gasket
791 2	4812 530 58099	Gasket
791 4	4812 466 68503	Gasket
791 5	4812 466 68504	Gasket
794 1	4819 530 58032	Gasket 20x2,5
901 0	4822 401 10492	Clamp,hose 14-24 mm
901 1	4812 401 18424	Strap 050,0
901 2	4812 401 18157	Strap 32-50/9 C61
901 7	4812 401 18427	Strap 031,6
904 2	4812 462 79635	Cover WH 3,5x5
910 0	4812 502 18384	Screw 4x35-H
910 1	4812 502 18394	Screw 3,5x14-H
910 2	4812 502 18363	Screw 4,0x12-H
910 3	4812 502 18389	Screw NIRO A2
910 4	4812 502 18385	Screw M3,5x8-T15M
910 5	4812 502 18393	Screw 3,5x9-1 Tx15
910 7	4812 502 18397	Screw INOX A2 M 5X12
910 9	4812 502 18446	Screw 3,5x16
964 0	4812 466 68536	Gasket housing ri/le
964 1	4812 466 68469	Gasket housing upper
993 0	4819 530 29028	Bow
993 5	4822 532 80216	Funnel salt

<https://whirlpooldishwasherusermanual.wordpress.com/>

Exploded view

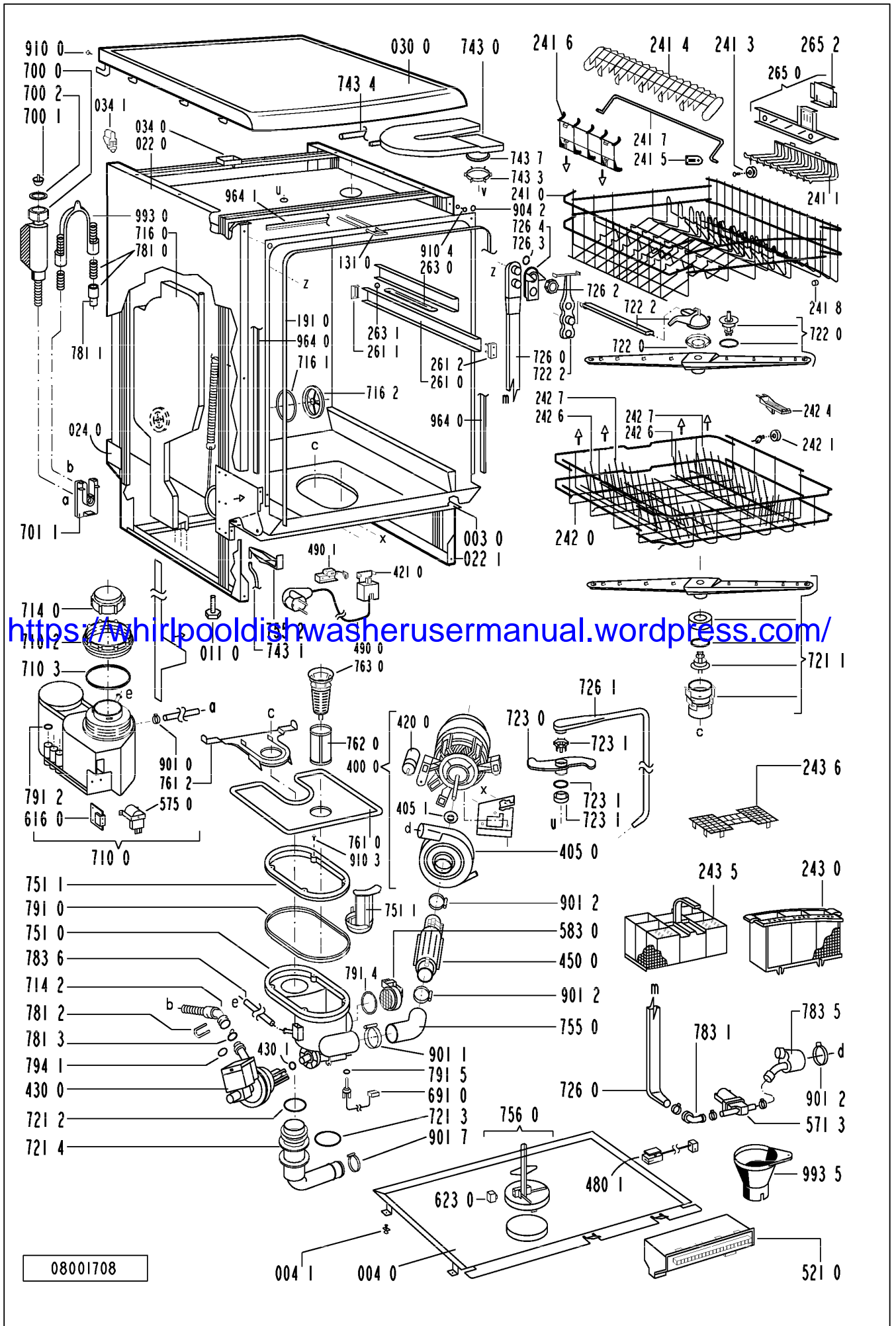

Exploded view

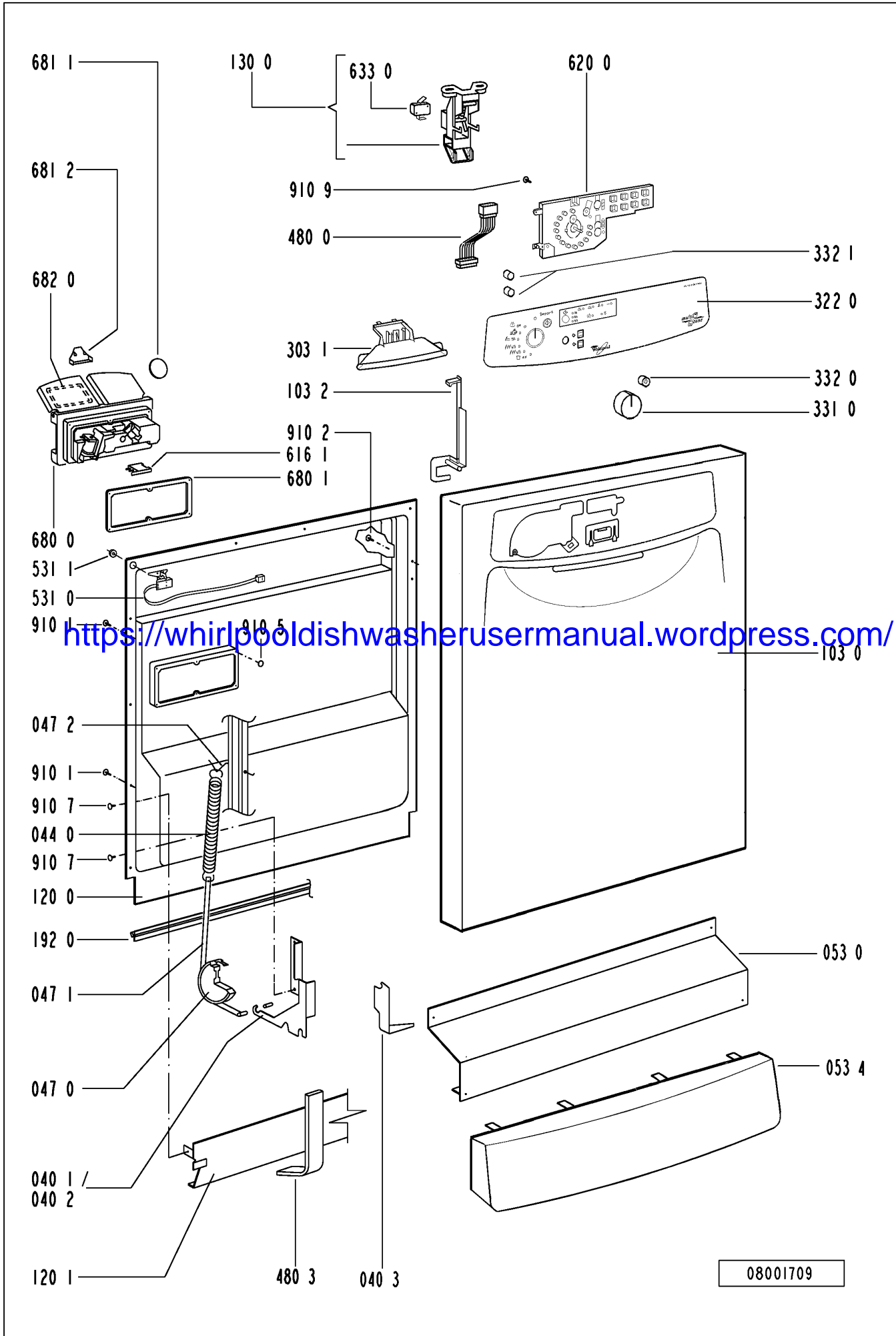

08001709

Circuit diagram

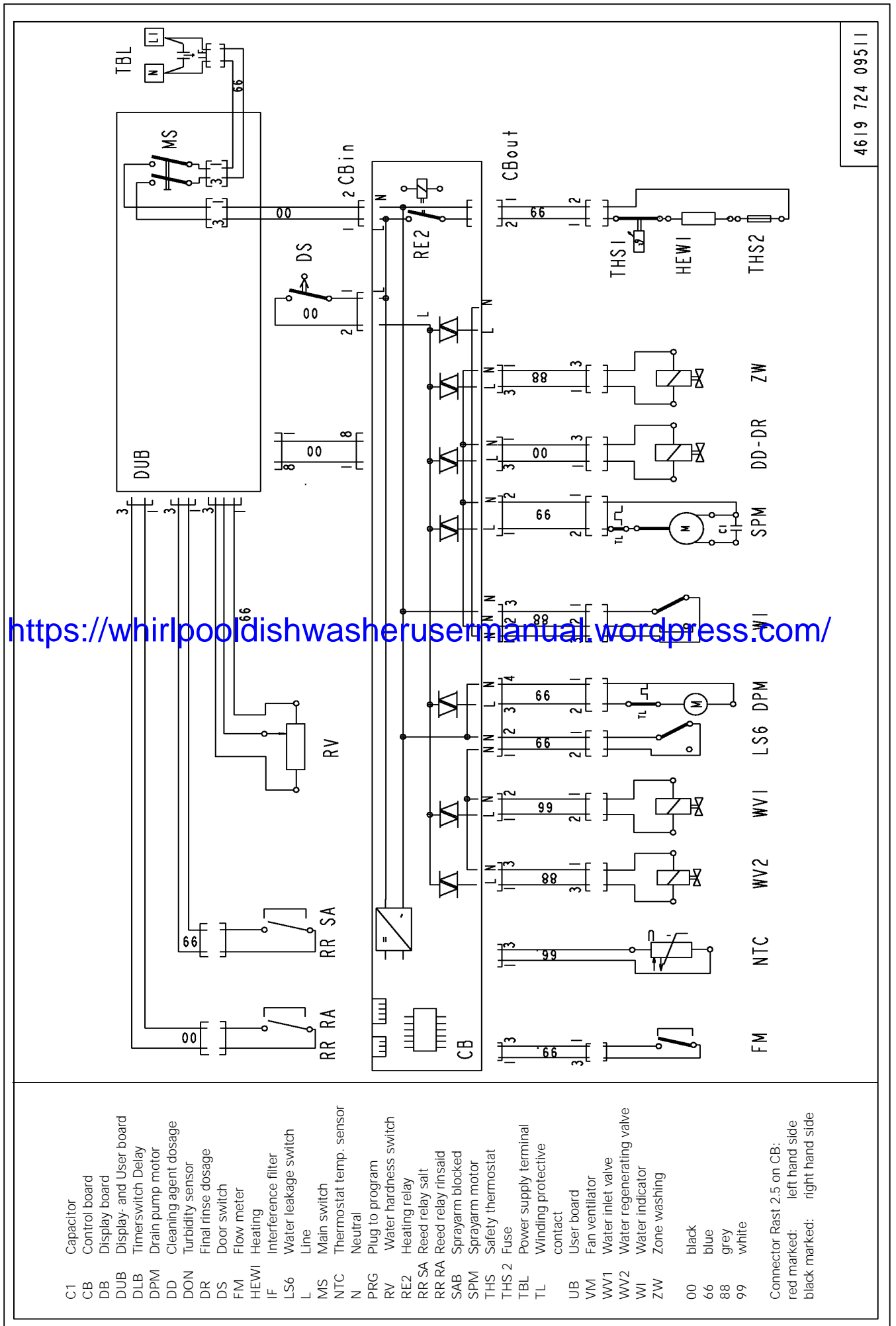

<https://whirlpoldishwasherusermanual.wordpress.com/>

- C1 Capacitor
- CB Control board
- DB Display board
- DUB Display- and User board
- DLB Timerswitch Delay
- DPM Drain pump motor
- DD Cleaning agent dosage
- DON Turbidity sensor
- DR Final rinse dosage
- DS Door switch
- FM Flow meter
- HEWI Heating
- IF Interference filter
- LS6 Water leakage switch
- L Line
- MS Main switch
- NTC Thermostat temp. sensor
- N Neutral
- PRG Plug to program
- RV Water hardness switch
- RE2 Heating relay
- RR SA Reed relay salt
- RR RA Reed relay rinsaid
- SAB Sprayarm blocked
- SPM Sprayarm motor
- THS Safety thermostat
- THS 2 Fuse
- TBL Power supply terminal
- TL Winding protective contact
- UB User board
- VM Fan ventilator
- WV1 Water inlet valve
- WV2 Water regenerating valve
- WTI Water indicator
- ZW Zone washing
- 00 black
- 66 blue
- 88 grey
- 99 white

Connector Rast 2.5 on CB:
red marked: left hand side
black marked: right hand side

Program diagram

no program function

I contact or triac closed

FM $\frac{1}{10}$ amount of water

t2 heating time up to temp.

t3 draining time up to the waterindicator is low

function of the machine

Startposition for all Progr.

function	VM	ZW	DD-DR	SPM	RE2	WI	DPM	WV2	WV1		Back-rinse	Prewash	Mainwash	Intern-rinse	Clear-rinse	Drying	PS1 or PS2	PS1	PS2	PS3	PS4
draining										t3+30 s											
filling + draining (1 lit.)										FM $\frac{1}{10}$											
pause										3 s											
filling + draining (1 lit.)										FM $\frac{1}{10}$											
pause										3 s											
filling + draining (1 lit.)										FM $\frac{1}{10}$											
pause										3 s											
draining										10 s											
filling - rinsing										FM $\frac{1}{10}$											
rinsing - heating										t2 = °C											
rinsing										min											
rinsing - draining										t3+30 s											
filling - rinsing										FM $\frac{1}{10}$											
rinsing - dos. detergent										3 s											
rinsing - heating										t2 = °C											
rinsing										min											
rinsing - heating										t2 = °C											
rinsing										min											
rinsing - draining										t3+30 s											
filling - rinsing										FM $\frac{1}{10}$											
rinsing										6,5 min											
rinsing - draining										t3+30 s											
rinsing										min											
rinsing - draining										t3+30 s											
filling - rinsing										FM $\frac{1}{10}$											
rinsing - heating										t2 = °C											
rinsing - dos. rinse aid + heat										1 min											
rinsing - heating										3 s											
rinsing - dos. rinse aid + heat										1,5 min											
rinsing - heating										t2 = °C											
rinsing										min											
draining										t3+30 s											
drying - regenerating										2 min											
drying										min											
drying - draining										t3+30 s											
drying										1 min											
drying - filling										1 s											
drying										3 s											
drying - filling										1 s											
drying - draining										+30 s											
drying										11 min											
drying - draining										+30 s											
End										End											

function	VM	ZW	DD-DR	SPM	RE2	WI	DPM	WV2	WV1		Back-rinse	Test-program Service	Test-program Plant
draining										t3+30 s			
filling + draining (1 lit.)										FM $\frac{1}{10}$			
pause										3 s			
filling + draining (1 lit.)										FM $\frac{1}{10}$			
pause										3 s			
filling + draining (1 lit.)										FM $\frac{1}{10}$			
pause										3 s			
draining										10 s			
filling - rinsing										FM $\frac{1}{10}$			
pause - dos. detergent										6,5 min			
rinsing - heating										30 s			
regenerating										t3			
regenerating - draining										30 s			
drying-regenerating-draining										t3			
End										End			

Only sensor programs.

d : drain out depends on soil level

f : water fill (f) water was drained out before

h : heating up to 40°C till 55/70°C depends on soil level

r : rinsing time 0 min, till 12 min, depends on soil level

Sensor failure are indicated only in the active test program

Warm water supply: spray-time guaranteed, depending on program: in cleaning cycle: 7 till 25 min, in final rinse: 4 till 6,5 min.

on 3b drying only 2 min.

Text/Legend

**Test procedure for SERVICE-TEST-PROGRAM DOLPHIN dishwashers
Whirlpool VBL without 2 digit 7 segment-display**

Switch on the appliance. If there is no failure indicated, than:

1. Start the passive test program.
If there is a defective component indicated, open the plinth and take out the control board (CB).
2. Check the component.
Unplug the indicated component from the control board (CB) and check it by using an Ohm-measure equipment.
If the ohms are not correct, check the cables to the component and check the component itself.
3. Check the control board (CB).
4. At the end of the repair start the appliance and delete the failure. After this, start the passive and active test program again to see that the failure is solved.

More details: s. following pages.

Attention:

First unplug the appliance, then set the connection clamps of the volt measurement on the test points.

<https://whirlpooldishwasherusermanual.wordpress.com/>

Danger for short circuit: Short circuits on components can damage the control board (CB).

If electronic boards are wet, do not switch the appliance on.

For check the appliance, plug in the appliance.

Failures, which occurred during the program will store and indicate by flashing start LED.

Then start the test program without erase the failure before. The failure will indicate.

To erase the failures, you must push the start button longer than 3 seconds.

The failures

- F1 NTC break
- F2 water leakage
- F9 continuous water inlet

are checked and indicated immediately after start of the program.

Therefore these failures have to be solved before starting the active test program.

When these failures are not solved, the active test program does not run.

The electrical components get their voltage via triac from the control board (CB). For testing the volume of voltage the volt meter must be parallel to the component (the component must be connected). If the component is disconnected, then the outcomed voltage from the control board (CB) is reduced.

After starting a program this program is locked. That means neither by unplugging/switching of the appliance nor by setting an other program, the first setted program can be changed. Changing of the program is only possible by pushing the start button again for longer than 3 sec..

Attention: On new service control boards the first service test program is without back rinsing. Dangerous for overfilling the appliance, in case the appliance is not empty. By running the test program a second time the back rinsing will be carried out as usual.

Text/Legend

Handling of failures

F0 Sensor failure

Will not indicate for the customer. The programs will finish even there is a failure. The Failure is indicated only in the active test program after 10 – 30 second's. The active test program will finish as well, even there is a failure.

If the failure in a sensor program appear, the machine will always choose the highest consumption (best cleaning result).

- None or wrong output from the sensor
- Unlogical or unreal measurement results

Reason:

- Defective electronic of the sensor
- Optoelectrical parts in the sensor defect
- Case of the sensor is very dirty
- Connection between sensor and control board (CB) interrupted

Attention: The failure code will not store.

F1. NTC break

Temperature out of the normal value (-3°C till +85°C)

- temperature inside higher than +85°C
- NTC defective
- dishwasher is frozen, less than -3°C

Fill in the appliance a cup of warm water to warm it up before you start it, if the temperature is less than -3°C

<https://whirlpooldishwasherusermanual.wordpress.com/>

F2. water leakage

- water is in the drip tray

float (LS6) switches off the WV1 and the electronic switches on the DPM till WI reports empty

F3. heating system defective

Indicated after app. 25 minutes (1. check after 5 min., after that follow 2 more checks, before the failure is indicate)

- too less heating speed (lower 1,5 °C in 10 min.)
- heating (HEW) defective
- relays (RE2) on control board (CB) is defective
- NTC - resistance fluctuation
- water indicator (WI) defective (is switched off) - spray pump (SPM) is not working

F4. draining failure

drain pump starts and after 4 min. the WI detects not empty

- drain pump (DPM) defective
- siphon closed
- control board (CB) defective
- water indicator (WI) defective (is switched on)

F6. water tap closed (only indicated after start of the active test program)

water valve (WV1) is switched on but flow meter (FM) sends no impulses (less than 10 imp. in 10 sec.) and the water indicator (WI) is off (empty)

- water tap closed
- water inlet hose blocked
- water inlet valve (WV1) defective
- flow meter (FM) defective (leads to FM failure)

Text/Legend













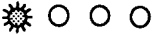

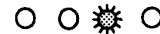

- F7. flow meter failure
water inlet valve (WV1) is switched on and the water indicator (WI) is on (full).
- flow meter (FM) sends to less impulses (less than 10 imp. in 10 sec.)
- water tap closed
- water inlet hose blocked
- water inlet valve (WV1) defective
- flow meter (FM) defective
- F8. water level failure
failure monitored during spray pump is on and the water indicator switches back more than 20 times in 2 min.
- water indicator defective (should switch on after app. 1 litre)
- sieve blocked
- water strongly foams
- pot has turned off and is filled with spray water
- no stable spray pump (SPM) working
- F9. continuous water inlet
water inlet valve (WV1) is switched off, water indicator (WI) on, flow meter (FM) sends impulses (more than 10 imp. in 10 sec.)
- water inlet valve (WV1) mechanically not closed
- triac (CB) permanently switched on. (short circuit)

<https://whirlpooldishwasherusermanual.wordpress.com/>

For salt, rinse aid, zone wash valve, sieve valve failure see active test program.

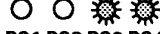
Text/Legend

FAILURECODES for Whirlpool VBL without 2 digit 7 segment display

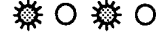
Alarm / Failures	Failurecode, which is indicated for the customer on the Start-LED and the Programsequence, directly after it's occurred	
	Both indications parallel on appliances with Programsequence	
	Indication on appliances without Programsequence	
F0 Sensore failure	Indicated only in the active testprogram START  10 x flashing 1s break 10 x flashing.....	 PS1 PS2 PS3 PS4
F1 NTC-break	START  1 x flashing 1s break 1 x flashing.....	 PS1 PS2 PS3 PS4
F2 Water leakage	START  2 x flashing 1s break 2 x flashing.....	 PS1 PS2 PS3 PS4
F3 Heating system defective	START  3 x flashing 1s break 3 x flashing.....	 PS1 PS2 PS3 PS4
F4 Draining failure	START  4 x flashing 1s break 4 x flashing.....	 PS1 PS2 PS3 PS4
F6 Water tap closed	START  6 x flashing 1s break 6 x flashing.....	 PS1 PS2 PS3 PS4
F7 Flow meter failure	START  7 x flashing 1s break 7 x flashing.....	 PS1 PS2 PS3 PS4
F8 Waterlevel failure	START  8 x flashing 1s break 8 x flashing.....	 PS1 PS2 PS3 PS4
F9 Continous waterinlet	START  9 x flashing 1s break 9 x flashing.....	 PS1 PS2 PS3 PS4

 LED flashing
 LED off

PS 1 till PS 4: Programsequence

- The failurecode "Sprayarm blocked (F5)" is not present on the Whirlpool VBL Version
- On the 1 digit 7 segment-display the failure will shown with a "F" in the display and a flashing Start-LED.
- The failure F0 (Sensor failure) will only indicated in the active testprogram, that means, this failure is not visible for the customer.

Text/Legend

VBL

5

4619 724 14971-1

With the passive test program, you can check all LED's and buttons. If there is no failure the passive test program runs normal.

Attention:

If you can't start the active test program (Start button don't flash), normally there is one of the following failures detected: F1, F2 or F9

When these failures are not solved before, the passive and active test program will not run. After solving the failure you must "sign" (erase) the failure.

A present failure will be indicate directly after you switch on the appliance

Start procedure

Start the passive test program if there is no failure indicated

If there is no failure the passive test program runs normal.

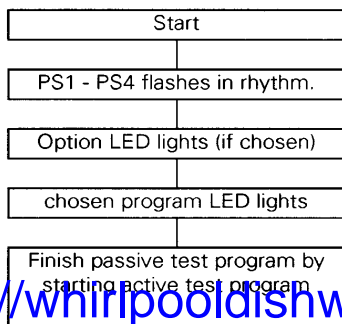

1. Switch off the appliance.
2. Push start button and hold it.
3. Choose programplace 1 (turn to the left side).
4. Finish pushing the start button when the start LED flashes.
5. Test all LEDs by operate the buttons and the programknob. After the check, turn the programknob on programplace 1
6. Start the active testprogram by pushing the start button again
7. Failure indication.
8. Repair the failure
9. Solve the failure by pushing the start button for longer than 3 sec.
10. Start the active testprogram again, to see, if the failure is really solved

<https://whirlpooldishwasherusermanual.wordpress.com/>

Active test program starts (see next page)

Program sequence LED

PS1	1. LED	prewash	
PS2	2. LED	mainwash intermediate rinse final rinse	
PS3	3. LED	drying (regeneration)	
PS4	4. LED	end	goes off if any button is pushed
			goes off after 30 min progr. is finished

Text/Legend

Active test program

Start

backrinsing
(only after the 2nd run
of the test program)

WV1 on
5 lt.

after 3,4 lt.
SPM + ZW on

ZW+SPM off
for 3 seconds

DD-DR on for 3 sec.

SPM on

After 5 sec. RE on till
65°C

SPM off

WV2 on

DPM on till WI low

VM on
WV 2 off

DPM off
VM off

end

Only on this step can be
jumped to the next step
by short pushing the
start button again

PS4
on

Remarks

The active test program runs to the failure position and stops or, if there is no failure, it runs to the end.

To leave the test program push the start button for longer than 3 second's.

Too less salt or too less rinse aid leads not to the stop of the appliance.

The function of the zone wash valve can only be checked optically.
A defect leads to a not stable SPM pressure.

When the failure position is reached, the failure indication is like on the page "Failurecodes"

Attention:

If you can't start the active test program (Start button don't flash), normally there is one of the following failures detected: F1, F2 or F9

When these failures are not solved before, the active test program will not run. After solving the failure you must "sign" (erase) the failure.

Remarks:

ZW on: zone wash valve on = no water on the upper sprayarm.

ZW off: zone wash valve off = water on the upper sprayarm.

<https://whirlpooldishwasherusermanual.wordpress.com/>