

# Service Manual

Dishwasher

integratable

ADG 6556 IXM

Model Version		Page
	ADG 6556 IXM	
	8542 556 10740	
	Technical data	2 - 4
	Spare part list	5 - 6
	Exploded view	7 - 8
	Circuit diagram	9
	Program diagram	10
	Text/Legend	11 - 17
	Family	VBL - MID 5

<https://whirlpooldishwasherusermanual.wordpress.com/>

**Technical data**

**Dimension**

Height	82.0 - 87.0	cm
Width	59.7	cm
Depth	55.5	cm
Weight	50	kg

**Wooden door for Integrable types**

Thickness min.	16	mm
Thickness max.	20	mm
Width min.	592	mm
Width max.	595	mm
Height min.	515	mm
Height max.	600	mm
Weight max.	5.5	kg
Max. stick out over lower edge of appliance door	92	mm
Height of plinth min.	93	mm

**Electronic boards**

Service boards	see spare part list
Serial boards	see on the boards itself
DUB	4619 724 06661
Programing of version and board, see "Service" and "Data set" on rating plate of inner door.	programmed control
CB programmed	442241
Data set	442231
Basic control board, not programmed	see on the board itself
	4619 724 17411

**Succession of programs**

Programs	see program diagram
Succession	A1a-A3a-A5b-A6a-A7a

**Datas Energy Label**

Reference program	A5b
Energy Performance	B
Cleaning Performance	A
Drying Performance	B

**Options**

Zone washing	
Delay function	

**Program information**

Start indicator	
Pre wash	
Main wash	
Drying	
End	

All programs will be locked after start. Changing the program or finishing the program will be possible only after pressing the start button for longer then 1.5 sec. (Break by customer)

A switching off the appliance or unplug the appliance for a while, this will frozen the program step and later on, the program continuos on the same position.

Exception: Switching off the appliance or unplug the appliance during the drying phase, this will lead directly to the end of the program.

**Water Volume at alternating spray system**

Volume at alternating spray system (same level when selected zone washing as in the normal programs)

Water	Volume	Level
Regeneration	0.3 l	15 mm
Back rinse 3x	1.0 l	60 mm
Prewash	3.9 l	120 mm
Main wash	3.2 l	118 mm
Intermediate rinse 1	3.2 l	118 mm
Intermediate rinse 2	3.2 l	118 mm
Clear rinse	3.2 l	118 mm
Safety/ overflow	8.5 l	141 mm

**Measuring the level**

Remove the coarse sieve, put in a measuring meter into the sump, measure the hight of the water level.

**Detergent max.**

Pre-wash	10	cm <sup>3</sup>
Main-wash	40	cm <sup>3</sup>
Rinse aid	135	cm <sup>3</sup>
6 Dosage steps	1 - 6	ml

**Water softener**

Saltcontainer	2	kg
Resin container	900	cm <sup>3</sup>
Regeneration dosage	300	cm <sup>3</sup>

<https://whirlpooldishwasherusermanual.wordpress.com/>

## Technical data

### Water pressure

Inlet pressure	0.3 - 10	bar
Spray pump pressure	0.3	bar

### Rotations

Spray pump motor	2800	RPM
Drain pump motor	3000	RPM
Spray arm lower	30 - 40	RPM
Spray arm upper	30 - 40	RPM

### Spray arms, turning rhythm at alternating spray system

Turning starts every time with the upper spray arm

Pre wash Lower arm ~3min, Upper arm ~1min

Main wash Lower arm ~3min, Upper arm ~5min

Intermediate rinse

Lower arm ~2min, Upper arm ~2min

Final rinse Lower arm ~2min, Upper arm ~2min

Service Test program

Lower arm ~30sec, Upper arm ~30sec

<https://whirlpooldishwasherusermanual.wordpress.com/>

Remark: When switching of the main switch or interrupt the mains during the Test Program runs, then the alternating of the spray arms change in the test program to the rhythm of main wash 5/3 min.

Important: To leaf the Test program is possible by made a break by customer (pushing the start button for 1.5 sec.)

After finishing the test program (End LED shines and/or Start LED goes of) must the appliance be switched off.

If this will not be done, then the next normal wash will be made with the frequency of the Service Test Program ~30/30sec.

### Flow rates/ Inlet volume

Flow meter (at 0.3 bar = quantity 1.1 l/min)	208	lmp/l
Spray pump	45 - 65	l/min
Drain pump	16	l/min
Pump height max.	1.1	m
Inlet valve	4	l/min
Spray arm lower	~ 33	l/min
Sprayarm upper	~ 27	l/min
Shower top	~ 8	l/min

### Electrical base data

Voltage	220/ 230	V
Frequency	50	Hz
Total power	2.0 - 2.2	kW
Fuse	10	A

### Spray pump motor alternating spray system

Voltage	220/ 240	V
Power consumption	125	W
HI	79	Ω
HA	60	Ω
Capacitor	4	μ F

### Drain pump motor

Voltage	220/ 240	V
Power consumption	30	W
Resistance	146	Ω

### Heating

#### 1 Element system

Voltage	220/ 230	V
Power consumption	1.87/ 2.04	kW
Resistance	24.5	Ω
Heating speed	~ 2.0	°C/min
Temperature on surface	~ 115	°C
Safety thermostat self reset		
(Temperature of water)	~ 85	°C
Fuse	206	°C

### Potentiometer

Points of measurement:	1 (black) to 2 (middle)
Position 0	0.0 kΩ
Position 1	0.5 kΩ
Position 2	1.0 kΩ
Position 3	1.4 kΩ
Position 4	1.8 kΩ
Position 5	2.3 kΩ
Position 6	2.6 kΩ

### Water valves

#### Single electric inlet valve

Voltage	220/ 240	V
Frequency	50/ 60	Hz
Resistance	3.76	kΩ

**Technical data**

**Regenerating valve**

Voltage	220/ 240	V
Frequency	50/ 60	Hz
Resistance	3.13	kΩ

**Motor Diverter Valve**

Voltage	220 - 240	V
Frequency	50/ 60	Hz
Resistance	6.5	kΩ
Signal (2x within ~13 sec.)	5.0	V

**Coil of dispenser**

Voltage	220/ 240	V
Frequency	50/ 60	Hz
Resistance	1.3	kΩ

**Reed contacts**

flow meter  
 salt control  
 rinse aid control

**NTC**

20 °C	58.1	kΩ
25 °C	47.1	kΩ
30 °C	38.2	kΩ
40 °C	25.4	kΩ
50 °C	17.2	kΩ
60 °C	11.8	kΩ
70 °C	8.3	kΩ
80 °C	6	kΩ
85 °C	4	kΩ

**Regeneration**

Volume	300	cm <sup>3</sup>
Position 0 after wash cycles	12	
water hardness	0 - 5	°dh
	0 - 0.9	mmol/l
	0 - 9	°Fh
Position 1 after wash cycles	10	
water hardness	6 - 10	°dh
	1 - 1.8	mmol/l
	10 - 18	°Fh
Position 2 after wash cycles	7	
water hardness	11 - 15	°dh
	1.9 - 2.7	mmol/l
	19 - 27	°Fh
Position 3 after wash cycles	5	
water hardness	16 - 21	°dh
	2.8 - 3.7	mmol/l
	28.37	°Fh
Position 4 after wash cycles	3	
water hardness	22 - 28	°dh
	3.8 - 5.0	mmol/l
	66 - 80	°Fh
Position 5 after wash cycles	2	
water hardness	29 - 35	°dh
	5.1 - 6.3	mmol/l
	51 - 63	°Fh
Position 6 after wash cycles	1	
water hardness	36 - 60	°dh
	6.4 - 10.7	mmol/l
	64 - 107	°Fh
Salt consumption for regeneration	77	g
Number of cycles with 2 kg salt	26	

<https://whirlpoldishwasherusermanual.wordpress.com/>

**Accessory**

If you need spare parts apart from the spare part list have a look in the Service Bulletin 4812 718 40084.

## Spare part list

**Model** ADG 6556 IXM  
**Service No.** 854255610740  
**Version** 854255610740

Pos. No.	12NC Code	Description
003 0	4812 440 19594	Traverse
004 0	4812 440 18952	Drip tray assy
004 1	4812 401 18402	Holder
011 0	4812 505 18369	Foot long
011 1	4812 528 98004	Shaft flexible
011 2	4812 528 78032	Slide disc f.foot
011 3	4812 535 98054	Gear
011 4	4812 528 98001	Roll f.foot
022 0	4812 440 19398	Side panel left
022 1	4812 440 19397	Side panel right
024 0	4812 440 10417	Panel, rear
040 1	4812 417 18774	Hinge left
040 2	4812 417 18773	Hinge right
044 0	4812 492 38362	Spring f.door
047 0	4812 404 48746	Brake f.door
047 1	4812 401 18397	Band,brake
047 2	4812 404 68023	Hook
053 0	4812 440 88884	Plinth
103 0	4812 440 19478	Door outer
105 0	4812 404 48611	Fastener door
105 2	4812 505 68004	Clip
120 0	4812 440 19456	Door,inner
120 1	4812 440 18969	Batten
130 0	4812 411 18378	Pin lock cpl. lock
131 0	4812 401 18416	Hook lock
175 3	4812 466 68572	Batten
191 0	4812 466 68564	Gasket door
192 0	4812 466 68467	Gasket, door lower
241 0	4812 458 19027	Basket upper straight
241 1	4812 458 18324	Holder cups right wh
241 3	4812 528 88068	Wheel,basket upper (set)
241 4	4812 458 18984	Holder dishes wh
241 5	4812 535 78043	Bearing
241 7	4812 404 48683	Hoop
241 8	4812 466 68553	Spacer cap set
242 0	4812 310 28136	Basket lower KIT
242 1	4812 528 88069	Wheel,basket lower wh
242 4	4812 466 48059	Fixation wh
242 6	4812 458 18977	Support plate left
242 7	4812 458 18978	Support plate right
243 0	4812 458 18272	Basket cutlery
243 5	4819 310 39859	Cutlery basket KIT
243 6	4812 458 18996	Grille wh
261 0	4819 462 38271	Rail telescope, inner
261 1	4812 462 79768	Cap rail
261 2	4812 462 78995	Cap rail ahead
263 0	4819 520 18013	Ball cage cpl.
263 1	4812 520 48001	Ball Niro 8 D
265 0	4812 404 48637	Basket adjustm. cpl.
265 2	4812 404 48638	Grip basket adjustment
301 0	4812 453 71488	Control panel INOX
303 1	4812 460 38089	Plate,handle BK
305 1	4819 502 18241	Screw synthetic
305 2	4819 505 18191	Nut
305 6	4812 440 19466	Batten silv-met.

Pos. No.	12NC Code	Description
331 0	4812 413 59018	Knob program cpl. BK
332 0	4812 410 28675	Button BK
332 2	4812 410 28672	Button BK
350 1	4812 381 28059	Window (WP-VBL-BI)
350 2	4812 381 28047	Lens
400 0	4812 361 58336	Motor +SP,50Hz,alt.LP-PNT1
405 0	4812 360 18509	Spray pump wo.Mot.alt.LP-50Hz
405 1	4819 515 28158	Gasket
420 0	4812 121 18132	Capacitor
421 0	4812 121 18158	Interf.filter
430 0	4812 360 18508	Pump,draining
430 1	4812 466 68689	Gasket
450 0	4812 259 28684	Heating element
480 0	4812 321 28405	Cable harness set
480 1	4812 321 28371	Cable
480 3	4812 401 18418	Protector f.wiring
490 0	4819 321 18136	Cable,mains 2m SA
490 1	4812 321 28367	Strain relief
521 0	4812 214 78642	Control board (CB)
531 0	4812 273 18055	Switch waterhardness
531 1	4812 273 18056	Wheel,fingertip
575 0	4812 281 28361	Regen.valve
583 0	4812 271 28407	Switch diaphragm
610 0	4812 281 18047	Contact,reed cap
616 1	4812 271 58161	Contact,reed rinsing agent
620 0	4812 218 38091	User board (DUB)
623 0	4812 271 38356	Microswitch
633 0	4812 271 38355	Microswitch door
680 0	4812 418 68155	Combidosage
680 1	4812 466 68495	Gasket
681 1	4812 466 68497	Gasket
681 2	4812 440 18975	Flap
682 0	4812 466 68496	Gasket
691 0	4812 282 68012	Feeler NTC
700 0	4812 530 28804	Hose, inlet aqua stop 4,2m
700 0	4812 530 28848	Hose, inlet aqua stop 2m
700 1	4812 480 48095	Sieve
700 2	4812 466 68628	Gasket
701 1	4812 310 18153	Yoke clamp set
710 0	4812 418 68151	Monoblock
710 2	4819 310 38536	Threaded ring
710 3	4819 466 69562	Gasket set
714 0	4812 462 78993	Threaded cap
716 0	4812 418 68147	Reg.dosage
716 1	4812 466 68475	Gasket
716 2	4812 462 78994	Cover
717 0	4812 281 28418	Valve motodiverter
717 2	4812 528 98011	Valve disk diverter
717 3	4812 530 29121	Gasket diverter valve
721 1	4812 360 68347	Spray arm lower. cpl.
722 0	4812 360 68348	Spray arm upper wh
722 2	4812 360 68349	Spray arm 2nd level cpl. wh
723 0	4812 360 68351	Douche ceiling
726 1	4812 530 29118	Tube assembly cpl.
726 2	4812 505 18208	Nut

<https://whirlpooldishwasherusermanual.wordpress.com/>

## Spare part list

**Model** ADG 6556 IXM  
**Service No.** 854255610740  
**Version** 854255610740

Pos. No.	12NC Code	Description
743 0	<b>4812 511 48171</b>	Capacitor
743 1	<b>4812 530 28102</b>	Hose, inlet
743 3	<b>4812 505 18364</b>	Nut
743 4	<b>4812 530 28807</b>	Hose 9x1,5x270+10
743 7	<b>4812 466 68514</b>	Gasket
751 0	<b>4812 418 18338</b>	Water collector
755 0	<b>4812 530 29119</b>	Bend
755 2	<b>4812 530 48148</b>	Tray,leak
756 0	<b>4812 360 58099</b>	Floater
761 0	<b>4812 480 58122</b>	Sieve fine
761 2	<b>4812 418 18337</b>	Cover sieve
761 3	<b>4812 418 18341</b>	Cover
761 4	<b>4812 530 58141</b>	O-Ring
763 0	<b>4812 480 58123</b>	Sieve coarse
781 0	<b>4812 530 29113</b>	Hose,draining
781 3	<b>4812 281 28417</b>	Flap non-return
783 6	<b>4812 530 28796</b>	Hose 10x3x180+10
791 0	<b>4812 532 68099</b>	Gasket
791 2	<b>4812 530 58093</b>	Gasket
791 4	<b>4812 466 68503</b>	Gasket
791 5	<b>4812 466 68504</b>	Gasket
900 1	<b>4812 310 28021</b>	Fastener set (not shown)
901 0	<b>4822 401 10258</b>	Clamp,hose 10-18 mm
901 1	<b>4812 401 18424</b>	Strap 056 0
901 2	<b>4812 401 18157</b>	Strap 32-30/9 C01
901 5	<b>4812 401 48573</b>	Strap 028,6
901 8	<b>4812 401 18075</b>	Strap 20-32/9 mm
902 1	<b>4812 466 78015</b>	Fastener f.buildt-in models
902 2	<b>4812 404 78241</b>	Holder
904 2	<b>4812 462 79657</b>	Cover BK 3,5x5
910 1	<b>4812 502 38152</b>	Screw 4,8x19
910 2	<b>4812 502 18363</b>	Screw 4,0x12-H
910 3	<b>4812 502 18389</b>	Screw 5x20 T20
910 4	<b>4812 502 18385</b>	Screw M3,5x8-T15M
910 5	<b>4812 502 18393</b>	Screw 3,5x9-1 Tx15
910 7	<b>4812 502 18397</b>	Screw INOX A2 M 5X12
910 8	<b>4812 502 18527</b>	Screw 4x15 T20
910 9	<b>4812 401 18425</b>	Screw 2,5x18-H
964 1	<b>4812 466 68573</b>	Gasket housing upper
993 1	<b>4812 466 78388</b>	Foil protection
993 2	<b>4812 404 48753</b>	Key foot
993 5	<b>4822 532 80216</b>	Funnel salt
993 6	<b>4812 466 78386</b>	Foil protection add.

<https://whirlpooldishwasherusermanual.wordpress.com/>

**Exploded view**

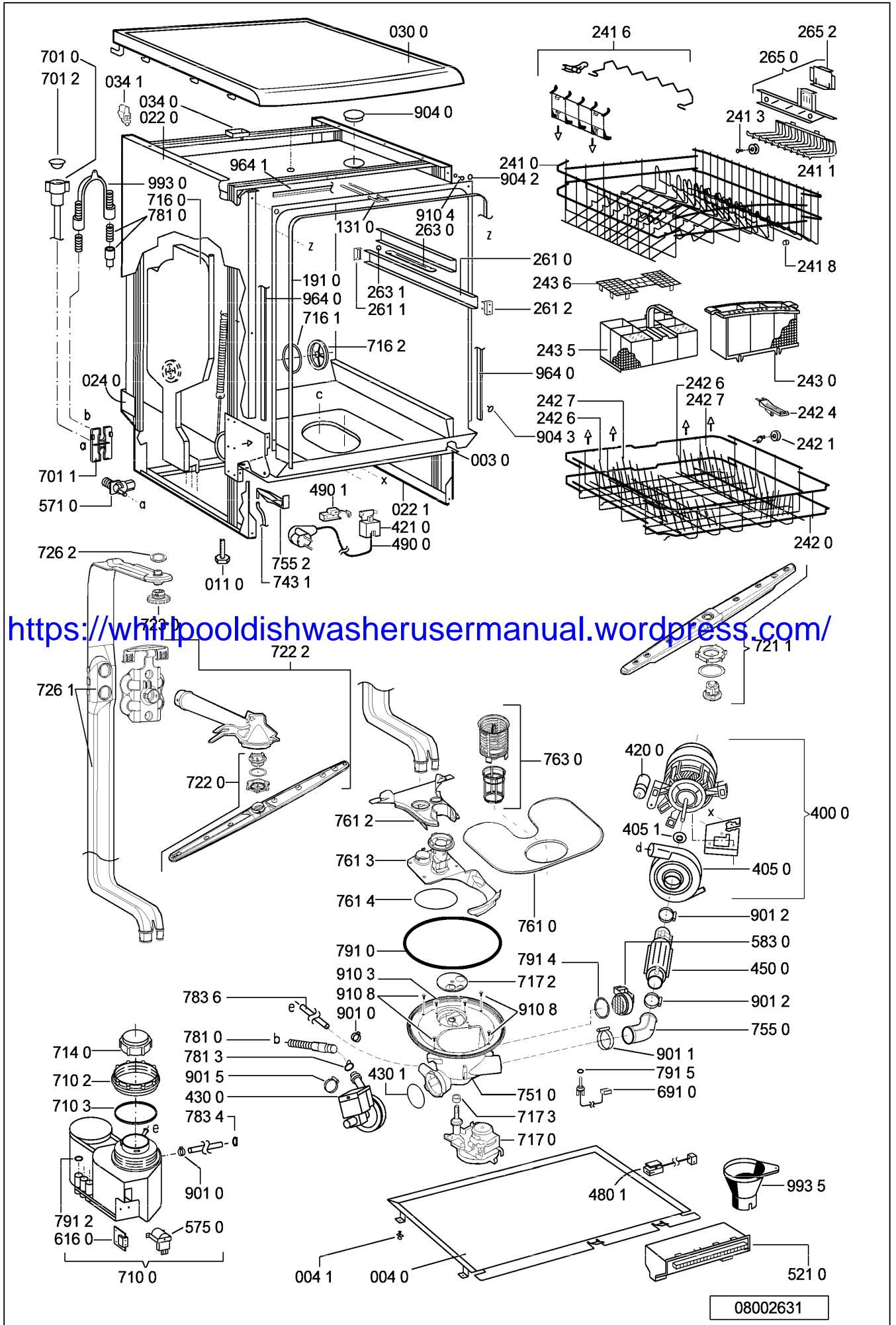

<https://whirlpooldishwasherusermanual.wordpress.com/>

08002631

**Exploded view**

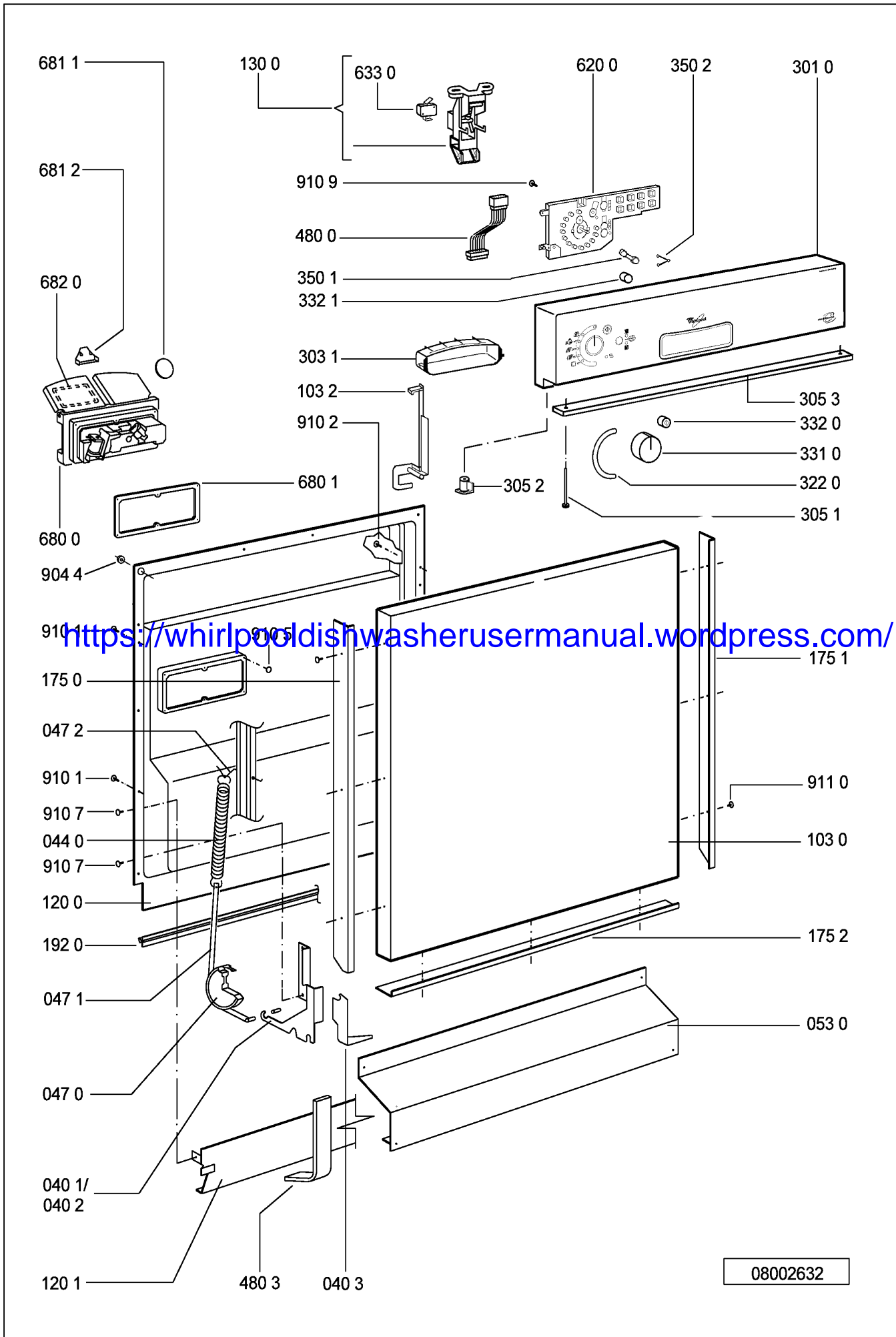



**Circuit diagram**

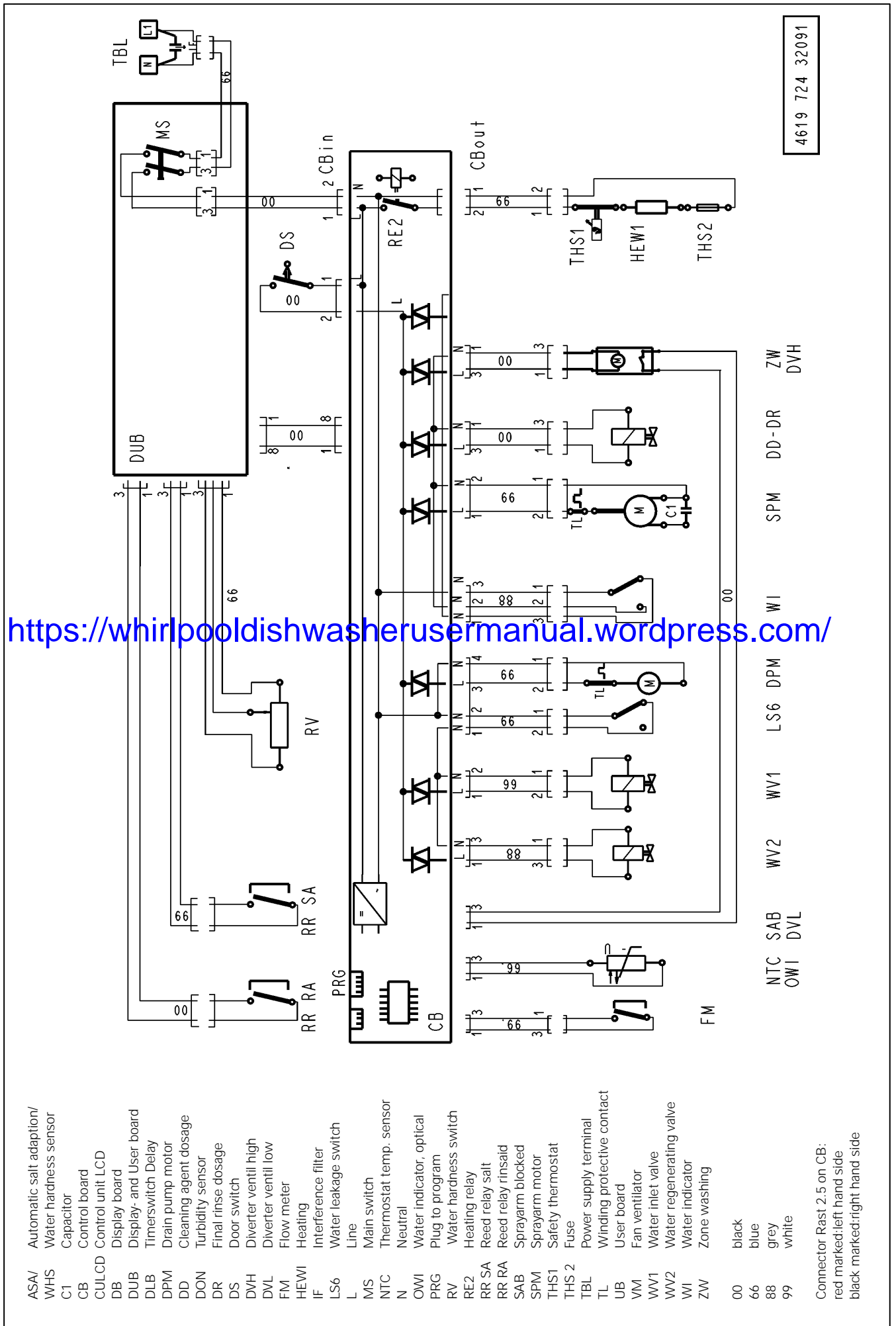

**Program diagram**

- no program function
  - contact or triac closed
- FM amount of water  
 t2 heating up to temp.  
 t3 draining time up to the water indicator is low

**Function of the machine**

Startposition for all progr. draining

draining

filling + draining (1ltr.)

pause

filling + draining (1ltr.)

pause

filling + draining (1ltr.)

pause

draining

filling - rinsing

rinsing - heating

rinsing

rinsing - draining

filling - rinsing

rinsing - dos detergent

rinsing - heating

rinsing

rinsing - heating

rinsing

rinsing - draining

filling - rinsing

rinsing

rinsing - draining

filling - rinsing

rinsing

rinsing - draining

filling - rinsing

rinsing - heating

rinsing - dos. rinse aid + heat

rinsing - heating

rinsing - dos. rinse aid + heat

rinsing - heating

rinsing

draining - regenerating

drying - regenerating

drying - regenerating - filling

drying - regenerating

drying - regenerating - filling

drying - draining

drying - without Fan

drying - with Fan

drying - draining

End

**Contacts**

Water inlet valve WW1
Regenerating valve 2 WW2
Drain pump DPM
Heating relay RE2
Spray pump SPM
Dosage detergent + rinse aid DD-DR
Diverter valve DVM
Ventilation drying (optional) VM

Program Table	A9a	A8a	A7a	A6a	A5b	A5a	A4a	A3a	A2a	A1a
Sensor Intensive										
Sensor Eco normal										
Intensive Program 70°C										
Normal Program 65°C										
Normal Program 50°C										
Eco Program 50°C										
Express Program 30°C										
Glasses program 40°C										
Prewash program cold										

Back rinse	Prewash	Mainwash	Intermediate rinse	Clear rinse	Drying
only after regeneration			step 1, step 2		
t3 + 30 s	t2 = °C	t2 = °C	t3 + 30 s	t2 = °C	1,5 min
3 s	min	min	t3 + 30 s	min	1 s
FM			FM		3 s
3 s			min		1 s
FM			t3 + 30 s		30 s
3 s			min		min
10 s			t3 + 30 s		min
FM			min		min
t2 = °C			t3 + 30 s		t3 + 30 s
min			min		End
t3 + 30 s			t3 + 30 s		
FM			min		
30 s			t3 + 30 s		
t2 = °C			min		
min			t3 + 30 s		
t2 = °C			min		
min			t3 + 30 s		
t3 + 30 s			min		
FM			t3 + 30 s		
min			min		
t3 + 30 s			t3 + 30 s		
min			min		
t2 = °C			t3 + 30 s		
30 s			min		
30 s			t3 + 30 s		
30 s			min		
t2 = °C			t3 + 30 s		
min			min		
t3 + 30 s			t3 + 30 s		
1,5 min			min		
1 s			t3 + 30 s		
3 s			min		
1 s			t3 + 30 s		
30 s			min		
min			t3 + 30 s		
min			min		
t3 + 30 s			t3 + 30 s		
End			min		

<https://whirlpooldishwasherusermanual.wordpress.com/>

**Function diagram**  
Point alternating wash

- d: drain out depends on soil level
- f: water fill if (d) water was drained out
- h: heating up to 40°C fill 70°C depends on soil level
- r: rinsing time 0 min. till 12 min. depends on soil level
- i: 2nd intermediate rinse depends on soil level
- XU = Upper spray arm working
- XL = Lower spray arm working
- X = time in min.
- Example:  
1U / 3L = 1 Min. Upper / 3 Min. Lower spray arm working

## Text/Legend

**Test procedure for SERVICE-TEST-PROGRAM Point dishwashers  
appliances with and without 7 Segment Display**

Switch on the appliance. If there is no failure indicated, then:

1. Start the passive test program.  
If there is a defective component indicated, open the plinth and take out the control board (CB).
2. Check the component.  
Unplug the indicated component from the control board (CB) and check it by using an Ohmmeter  
If the resistance is not correct, check the cables to the component and check the component itself.
3. Visibly check the control board (CB).
4. At the end of the repair start the appliance and delete the failure. After this, start the passive and active test program again to see that the failure is solved.

More details: see following pages.

**Attention:**

**Danger** for short circuit. Short circuits on components can damage the control board (CB).

If electronic boards are wet, do not switch the appliance on.

To check the appliance, plug in the appliance.

Failures, which occurred during the program will be stored and indicated by flashing the start LED.

The failure will be indicated and can be related to the failure table.

To erase the failures, you must push the start button longer than 1,5 seconds.

<https://whirlpooldishwasherusermanual.wordpress.com/>

The failures:  
E1 No tub lock  
F2 water leakage  
F9 continuous water inlet

are checked and indicated immediately after start of the program.

Therefore these failures have to be solved before starting the active test program.

When these failures are not solved, the active test program does not run.

The electrical components get their voltage via triac from the control board (CB). To test the voltage the voltmeter must be connected in parallel to the component (the component must be connected). If the component is disconnected, then the output voltage from the control board (CB) is reduced.

**After starting a program this program is locked. That means neither by unplugging/switching off the appliance nor by setting to another program, the first set program cannot be changed. Changing of the program is only possible by pushing the start button again for longer than 1,5 sec..**

**Attention: New service control boards start at first with the service test program. This test program is without back rinsing. Dangerous for overfilling the appliance, in case the appliance is not empty. By running the test program or another program a second time, the back rinsing will be carried out as usual.**

4619 724 43901-1

## Text/Legend

### **Handling of failures**

- F0 Sensor failure (only when a dirt sensor is installed )  
Will not be indicate to the customer. The programs will finish even if there is a failure. The Failure is indicated only in the active test program after 10 – 30 second's. The active test program will finish as well, even if there is a failure.  
If the failure in a sensor program appears, the machine will always choose the highest consumption (best cleaning result).
- None or wrong output from the sensor
  - Unlogical or unreal measurement results
- Reason:
- Defective electronic of the sensor
  - Optoelectronic parts in the sensor defect
  - The sensor is very dirty
  - Connection between sensor and control board (CB) interrupted
- Attention: The failure code will not store.

- F1. NTC break  
Temperature out of the normal value (-3°C till +85°C)
- Temperature inside higher than +85°C
  - NTC defective
  - Dishwasher is frozen, less than -3°C
- If the temperature is less than -3°C, fill the appliance with a cup of warm water to warm it up before you start it..

<https://Whirlpooldishwasherusermanual.wordpress.com/>

- F2. Water Leakage
- Water is in the drip tray
- Floater (LS6) switches off the WV1 and the electronic switches on the DPM until WI reports that it is empty.

- F3. Heating System Defective  
Indicated after app. 25 minutes (1. check after 5 min., after that follow 2 more checks, before the failure is indicate)
- Heats too slowly (less than 1,5 °C in 10 min.)
  - Heating (HEW) defective
  - Relays (RE2) on control board (CB) is defective
  - NTC - resistance fluctuation

- F4. Draining Failure  
Drain pump starts and after 4 min. the WI detects that it is "not empty"
- Drain pump (DPM) defective
  - Siphon closed
  - Control board (CB) defective
  - OWI/WI defective.

## Text/Legend

- F6. Water Tap Closed  
Water valve (WV1) is switched on but flow meter (FM) sends no impulses (less than 10 imp. in 10 sec.) and the water indicator (WI) is off (empty)
- Water tap closed
  - Water inlet hose blocked
  - Water inlet valve (WV1) defective
  - Flow meter (FM) defective (leads to FM failure)

- F7. Flow Meter Failure  
Water inlet valve (WV1) is switched on and the water indicator (WI) is on (full).
- Flow meter (FM) sends too few impulses (less than 10 imp. in 10 sec.)
  - Water tap closed during water inlet
  - Water inlet hose blocked
  - Water inlet valve (WV1) defective
  - Flow meter (FM) defective

- F8. Water Level Failure.  
Failures are supervised over the whole program.  
*Mechanical water indicator WI:* Spray pump works, the WI switches more than 20 times in 2 minutes back.  
*Optical water indicator OWI:* Always after the OWI-Signal is missing, the electrical components are turned off for 5 sec. If after the 5 sec. the OWI-Signal is still not present then, it notes a Failure F8. If, however, after the 5 sec. the OWI-Signal is present, then the water-level is filled to 6 Ltr. and the electrical components are again turned on. After the OWI signal is missing for a second time note an F8 Failure.
- WI defect? Should switch on after approx. 1 Ltr
  - Sieve blocked
  - Water strongly foams
  - Pot has turned off and is filled with spray water
  - No stable spray pump (SPM) working

- F9. Continuous Water Inlet  
Water inlet valve (WV1) is switched off, water indicator (WI) on, flow meter (FM) sends impulses (more than 10 imp. in 10 sec.)
- Water inlet valve (WV1) mechanically not closed
  - Triac (CB) permanently switched on. (short circuit)
- Reaction: interval 30 sec. drain pump on / 20 sec. drain pump off in interval

**The following failures will only be indicated, when the relevant component is installed.**

<https://whirlpooldishwasherusermanual.wordpress.com/>

## Text/Legend

### FA. OWI (Optical Water Indicator) – Failure

If the electronics signals of the Flow meter for the 3,4 Ltr. of water has been received on permanent wash system and 2,5 Ltr on alternating wash system and the OWI signal "Water in the sump" is missing then take note.

- Lens will be cleaned: Water inlet off for 10 Sec and SPM on for 10 Sec.
- If after that there is still no signal "Water in sump", then the appliance goes into failure mode FA.

### FB. MDV (Motor Diverter) – Failure

Failure condition:

Start water inlet. After 15 sec. switches the WI. After that, when not within 120 sec. comes a signal from the MDV to the control board, lower or upper spray arm is functioning, then the FB will indicate.

Check:

- Do the upper and lower spray arms alternate turns in approx. 30-40 sec.? If only one turns then there is a failure.
- Is the diverter disc in the sump blocked? Yes, unblock it.
- Does 230V come from the control board (ZW,DVH) to the MDV? No, change control board.

How to check:

Start test program and wait until backrinse is over. After the start of the regular water-inlet must come 230V within 30 sec. for approx. 20 sec. to the MDV.

- Is the winding of the MDV or cable to the MDV interrupted? (ZW,DVH) resistance of the MDV should be approx. 100 Ω.
- Is the signal cable between the MDV and control board (SAB,DVL) carrying 5v?

<https://whirlpooldishwasherusermanual.wordpress.com/>

### FC. ASA ( Automatic Salt Adaptation )/ Water hardness sensor Failure (only indicates in the active test program)

Failure condition:

Electronic on the water softener detects high electrical resistance in the resin.

Check:

























Cables on the sensors of the water softener interrupted or weak contact? Cables from the control board (ASA) to WHS electronic on the water softener interrupted or weak contact?

For salt, rinse aid, zone wash valve, sieve valve failure see active test program.

Text/Legend

**Failure Display POINT**

Appliances with 1 and 2-digit 7 Segment Display and without 7 Segment Display

Alarm / Failure	Failure code, Indication in test program when a failure occurs	
	Shown with 7 segment display or without 7 segment display	Shown on 2/3 digit 7 segment display
<b>F1 NTC-Failure</b>	START  1 x flash 1s Pause 1 x flash.....	
<b>F2 Water Leakage</b>	START  2 x flashes 1s Pause 2 x flashes.....	
<b>F3 Failure in Heating System</b>	START  3 x flashes 1s Pause 3 x flashes.....	
<b>F4 Draining Failure</b>	START  4 x flashes 1s Pause 4 x flashes.....	
<b>F6 Water Tap closed</b>	START  6 x flashes 1s Pause 6 x flashes.....	
<b>F7 Flow Meter Failure</b>	START  7 x flashes 1s Pause 7 x flashes.....	
<b>F8 Water Level Failure</b>	START  8 x flashes 1s Pause 8 x flashes.....	
<b>F9 Continuous Waterinlet</b>	START  9 x flashes 1s Pause 9 x flashes.....	
<b>F0 Sensor-Failure (Only displayed in act. test program)</b>	START  10 x flashes 1s Pause 10 x flashes.....	
<b>FA OWI-Fehler</b>	START  11 x flashes 1s Pause 11 x flashes.....	
<b>FB MDV-Fehler</b>	START  12 x flashes 1s Pause 12 x flashes.....	
<b>FC ASA-Fehler (Only displayed in act. test program)</b>	START  13 x flashes 1s Pause 13 x flashes.....	

<https://whirlpooldishwasherusermanual.wordpress.com/>

 LED flashing

- "Rotor blocked (F5)" isn't displayed on the POINT appliance

## Text/Legend

With the passive test program, you can check all LED's and buttons. If there is no failure the passive test program runs normally.

**Attention:**

If you can't start the active test program (Start button doesn't flash), normally there is one of the following failures detected: F1, F2 or F9

When these failures are not solved before, the passive and active test program will not run. After solving the failure you must "sign" (erase) the failure.

A present failure will be indicate directly after you switch on the appliance. Then fix the mistake, erase failure and start test program again (see following start procedure).

### Start procedure

Start the passive test program if there is no failure indicated

If there is no failure the passive test program runs normally.

<https://whirlpooldishwasherusermanual.wordpress.com/>

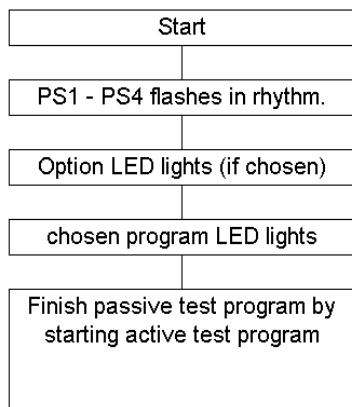

1. Turn OFF appliance
2. Push start button and hold it.
3. Select program position 1.( turn to the right or with WP VBL turn to the left)
4. Finish pushing the start button when the start LED flashes.
5. Test all LEDs by operating the buttons and the program knob. After the check, turn the program knob on to program place 1
6. Start the active test program by pushing the start button again
7. Failure indication.
8. Repair the failure
9. Solve the failure by pushing the start button for longer than 1,5 sec.
10. Start the active test program again, to see, if the failure is really solved

**Active test program starts (see next page)**

PS1	1.LED	prewash		
PS2	2.LED	mainwash		
		intermediate rinse		
		final rinse		
PS3	3.LED	drying (regeneration)		
PS4	4.LED	end	goes off if any button is pushed	goes off if after 30 min prog. Is finished



**Text/Legend**

**Active test program**



<https://whirlpooldishwasherusermanual.wordpress.com/>

Only on this step can be jumped to the next step by short pushing the start button again. Before jumping to the next step, wait for 3 minutes, to be sure, there is no FB failure.

**Remarks**

The active test program runs to the failure position and stops or, if there is no failure, it runs to the end.

To leave the test program push the start button for longer than 1,5 second's.

Not enough salt or rinse aid will not stop the running of the appliance.

**Remark** When switching off the main switch or interrupting the mains, during the test program runs, then the alternating of the spray arms changes in the test program from 30/30 sec. to the rhythm of the main wash 5/3 min.

**Important** Leaving the test program is possible by making a break by the customer (Pushing the start button for more than 1,5 sec.).

After finishing the test program (End LED shines and/or Start LED goes off) then the appliance must be switched off.

If this is not done, then the next main wash will be made with the frequency of the Service Test Program ~30/30 sec. instead of 3/5 min.

When the failure position is reached the failure indication is indicated on the page "Failure Codes"

**Attention:**

If you can't start the active test program (Start button doesn't flash), normally there is one of the following failures detected: F1, F2 or F9

When these failures are not repaired before, the active test program will not run. After solving the failure you must "sign" (erase) the failure.